



1 LOCATION PLAN
 11x17 1:2500
 24x36 1:1250



SITE PHOTOS



#183

#185

2 SITE PLAN
 11x17 1/50" SCALE
 24x36 1/25" SCALE



GENERAL NOTES

DO NOT SCALE DRAWINGS
 ANY MISSING OR UNCLEAR DIMENSIONS TO BE REPORTED TO CTX FOR CLARIFICATION
 REFER TO STRUCTURAL ENGINEER NOTES FOR ALL DRAWINGS
 REFER TO MECHANICAL ENGINEERING PLANS FOR PLUMBING AND AIR CONDITIONING SYSTEMS INFORMATION
 REFER TO ELECTRICAL ENGINEERING DRAWINGS FOR ELECTRICAL LAYOUT AND SYSTEM INFORMATION

ANY DEVIATION FROM PLANNING APPROVED DOCUMENTS REQUIRES THE SUBMISSION OF A PLANNING REVISION NO EXCEPTIONS

-ZONING INSTITUTIONAL WOODLAND RES., RECREATIONAL
 -LOT SIZE 134,904 SQ FT

-SITE COVERAGE
 EXISTING - 22,020 SQ FT
 PROPOSED - 2,128 SQ FT
 TOTAL - 24,148 SQ FT
 EXIST. HARD SURF. - 73,001 SQ FT
 PROP. HARD SURF. - 0 SQ FT
 TOTAL HARD SURF. - 73,001 SQ FT

-SITE COVERAGE PERCENTAGE
 EXISTING - 16.32%
 PROPOSED - 1.58%
 TOTAL - 17.90%
 EXIST. HARD SURF. - 54.11%
 PROP. HARD SURF. - 0.00%
 TOTAL HARD SURF. - 54.11%

-FLOOR AREA
 EXISTING - 22,020 SQ FT
 PROPOSED - 1,873 SQ FT
 TOTAL - 23,893 SQ FT

-TANK CAPACITY
 EXISTING - 1,500,000 GAL
 PROPOSED - 0 GAL
 TOTAL - 1,500,000 GAL

-NUMBER OF CESSPITS
 EXISTING - 0
 PROPOSED - 1
 TOTAL - 1

-AREA OF ROOF
 EXISTING - 22,020 SQ FT
 PROPOSED - 2,128 SQ FT
 TOTAL - 23,893 SQ FT

APR 26 2023

SITE PLAN HAS BEEN PREPARED FROM EXISTING DRAWINGS & NOT A RECENT SURVEY. ALL DIMENSIONS TO BE VERIFIED ON SITE.

REVISIONS

FRANCIS PATTON
 #191 NORTH SHORE BERMUDA

TECHNICIAN: BMS
 REF: SDs 05450
 DATE: NAR 2023
 SCALE: AS NOTED



GENERAL NOTES

DO NOT SCALE DRAWINGS
 ANY MISSING OR UNCLEAR DIMENSIONS TO BE REPORTED TO CTX FOR CLARIFICATION
 REFER TO STRUCTURAL ENGINEER NOTES FOR ALL DRAWINGS
 REFER TO MECHANICAL ENGINEERING PLANS FOR PLUMBING AND AIR CONDITIONING SYSTEMS INFORMATION
 REFER TO ELECTRICAL ENGINEERING DRAWINGS FOR ELECTRICAL LAYOUT AND SYSTEM INFORMATION

ANY DEVIATION FROM PLANNING APPROVED DOCUMENTS REQUIRES THE SUBMISSION OF A PLANNING REVISION NO EXCEPTIONS

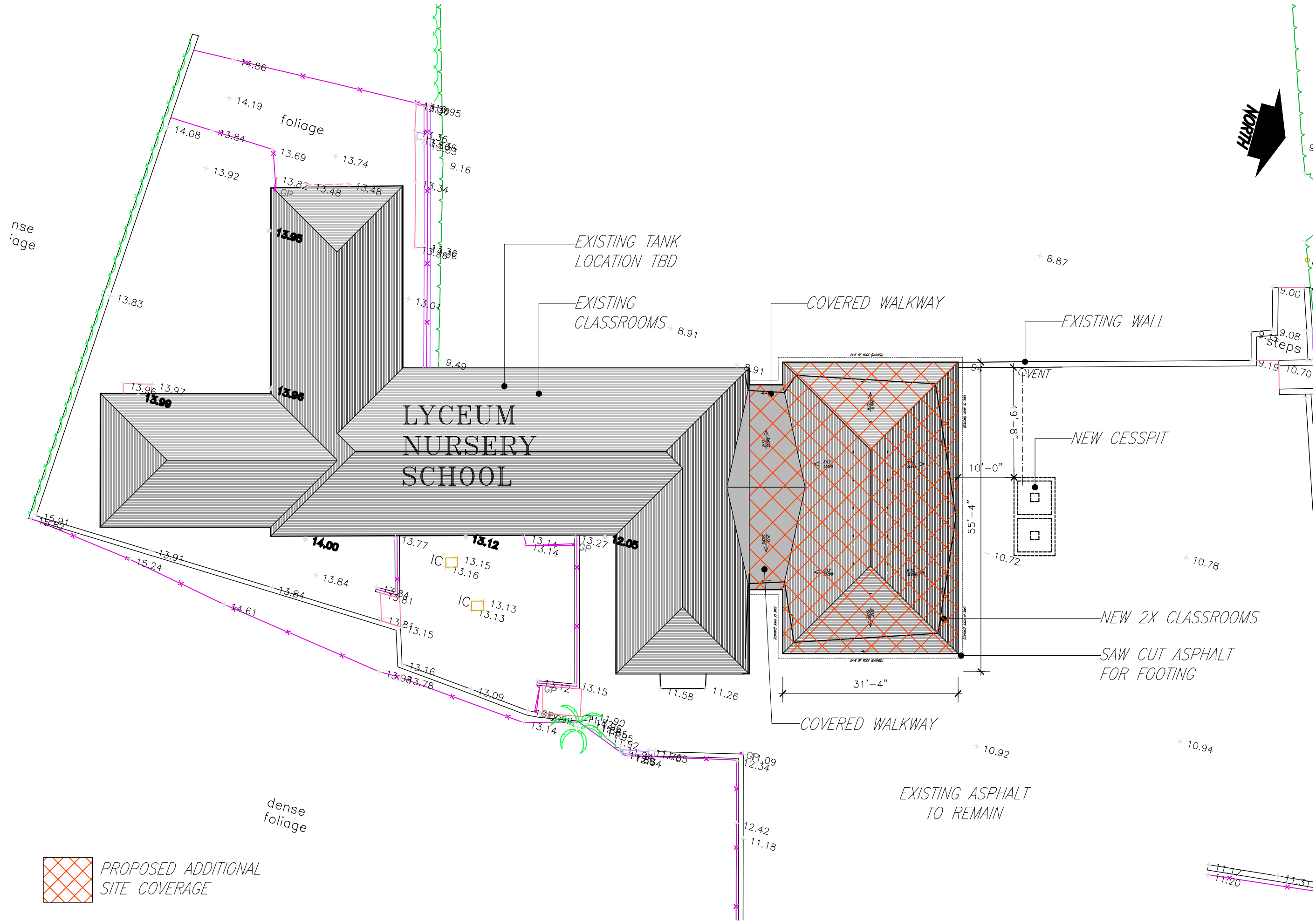

PROPOSED ADDITIONAL SITE COVERAGE

NEW 2X CLASSROOMS
 SAW CUT ASPHALT FOR FOOTING

APR 26 2023

SITE PLAN HAS BEEN PREPARED FROM EXISTING DRAWINGS & NOT A RECENT SURVEY. ALL DIMENSIONS TO BE VERIFIED ON SITE.

REVISIONS

FRANCIS PATTON
 #191 NORTH SHORE BERMUDA

TECHNICIAN: BMS
 REF: sDs 05450
 DATE: MAR 2023
 SCALE: AS NOTED

GENERAL NOTES

DO NOT SCALE DRAWINGS
 ANY MISSING OR UNCLEAR DIMENSIONS TO BE REPORTED TO CTX FOR CLARIFICATION
 REFER TO STRUCTURAL ENGINEER NOTES FOR ALL DRAWINGS
 REFER TO MECHANICAL ENGINEERING PLANS FOR PLUMBING AND AIR CONDITIONING SYSTEMS INFORMATION
 REFER TO ELECTRICAL ENGINEERING DRAWINGS FOR ELECTRICAL LAYOUT AND SYSTEM INFORMATION

ANY DEVIATION FROM PLANNING APPROVED DOCUMENTS REQUIRES THE SUBMISSION OF A PLANNING REVISION NO EXCEPTIONS

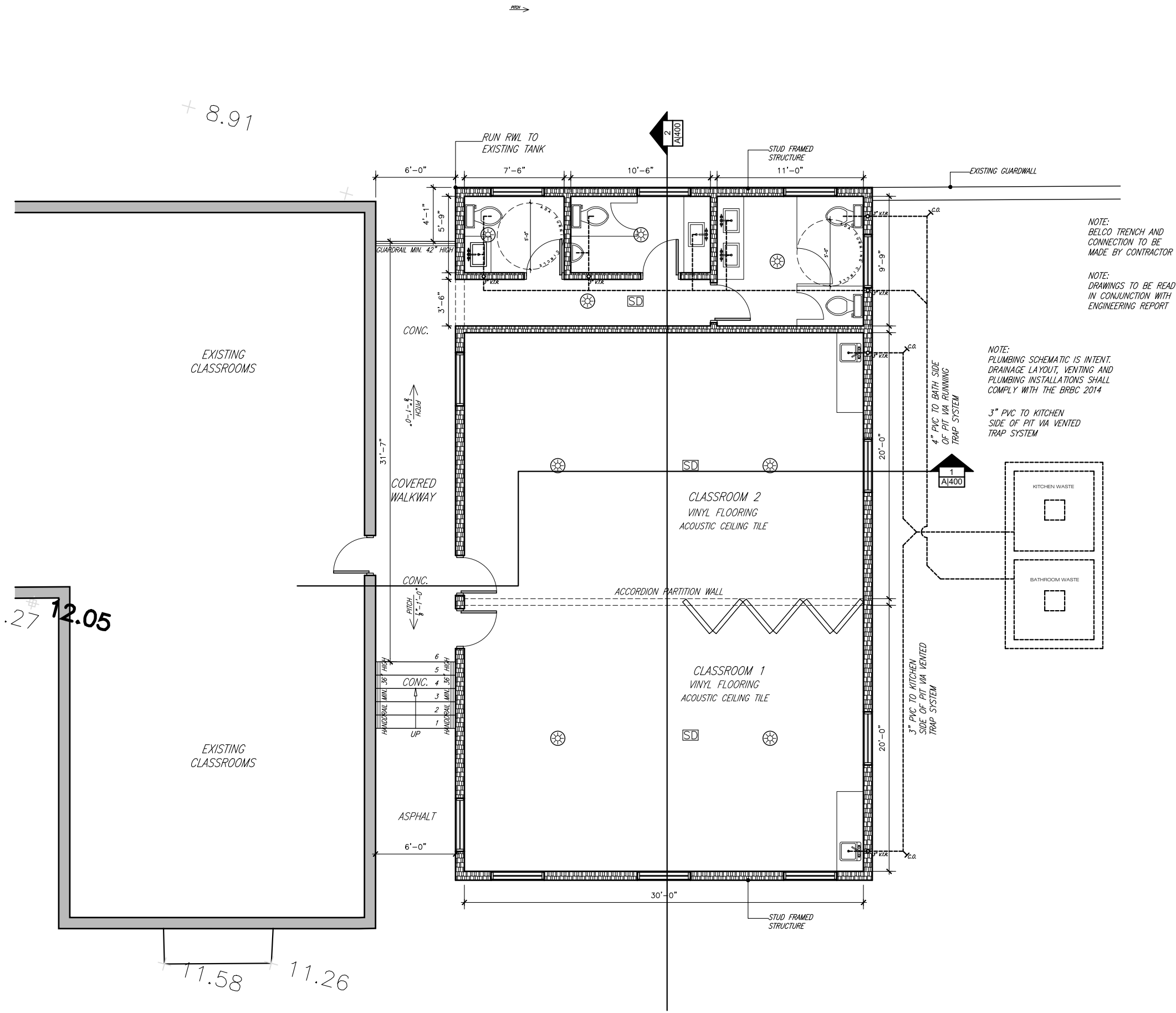

NOTE:
BELCO TRENCH AND CONNECTION TO BE MADE BY CONTRACTOR

NOTE:
DRAWINGS TO BE READ IN CONJUNCTION WITH ENGINEERING REPORT

NOTE:
PLUMBING SCHEMATIC IS INTENT. DRAINAGE LAYOUT, VENTING AND PLUMBING INSTALLATIONS SHALL COMPLY WITH THE BRBC 2014

3" PVC TO KITCHEN SIDE OF PIT VIA VENTED TRAP SYSTEM

4" PVC TO BATH SIDE OF PIT VIA RUNNING TRAP SYSTEM

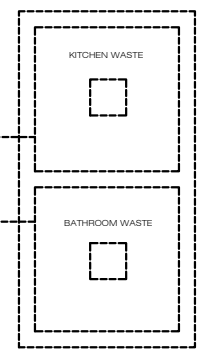

APR 26 2023

REVISIONS

FRANCIS PATTON

#191 NORTH SHORE BERMUDA

TECHNICIAN:
BMS

REF:
SDs 05450

DATE:
MAR 2023

SCALE:
AS NOTED

A/200

1

FLOOR PLAN

11x17 1/8" SCALE
 24x36 1/4" SCALE



GENERAL NOTES

DO NOT SCALE DRAWINGS
 ANY MISSING OR UNCLEAR DIMENSIONS TO BE REPORTED TO CTX FOR CLARIFICATION
 REFER TO STRUCTURAL ENGINEER NOTES FOR ALL DRAWINGS
 REFER TO MECHANICAL ENGINEERING PLANS FOR PLUMBING AND AIR CONDITIONING SYSTEMS INFORMATION
 REFER TO ELECTRICAL ENGINEERING DRAWINGS FOR ELECTRICAL LAYOUT AND SYSTEM INFORMATION

ANY DEVIATION FROM PLANNING APPROVED DOCUMENTS REQUIRES THE SUBMISSION OF A PLANNING REVISION NO EXCEPTIONS

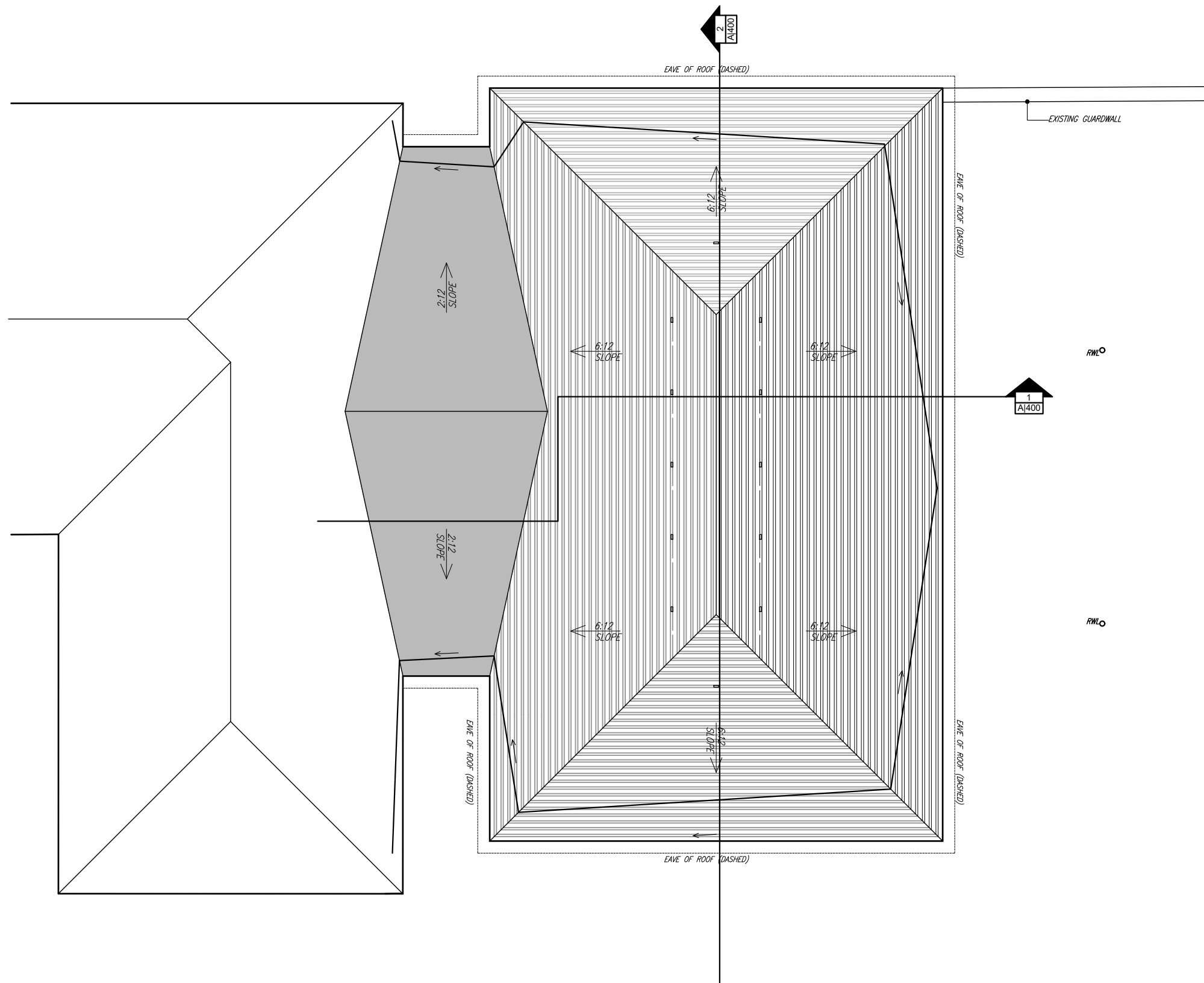

APR 26 2023

REVISIONS

FRANCIS PATTON

#191 NORTH SHORE BERMUDA

TECHNICIAN:
 BMS
 REF:
 sDs 05450
 DATE:
 MAR 2023
 SCALE:
 AS NOTED

1 ROOF PLAN
 11x17 1/8" SCALE
 24x36 1/4" SCALE

A/201



GENERAL NOTES

DO NOT SCALE DRAWINGS
ANY MISSING OR UNCLEAR DIMENSIONS TO BE REPORTED TO CTX FOR CLARIFICATION
REFER TO STRUCTURAL ENGINEER NOTES FOR ALL DRAWINGS
REFER TO MECHANICAL ENGINEERING PLANS FOR PLUMBING AND AIR CONDITIONING SYSTEMS INFORMATION
REFER TO ELECTRICAL ENGINEERING DRAWINGS FOR ELECTRICAL LAYOUT AND SYSTEM INFORMATION

ANY DEVIATION FROM PLANNING APPROVED DOCUMENTS REQUIRES THE SUBMISSION OF A PLANNING REVISION
NO EXCEPTIONS

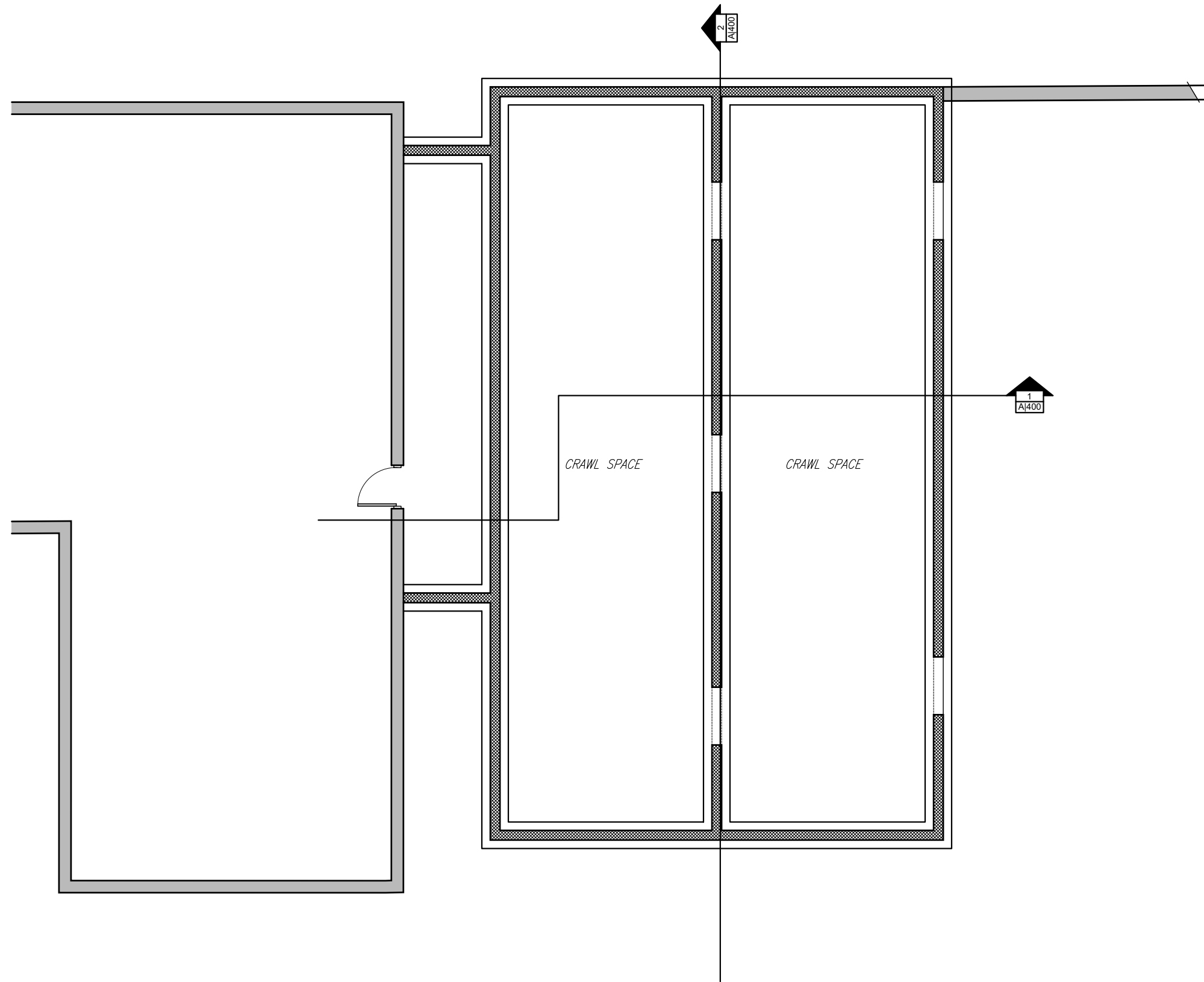

APR 26 2023

REVISIONS

FRANCIS PATTON

#191 NORTH SHORE
BERMUDA

TECHNICIAN:
BMS
REF:
SDs 05450
DATE:
MAR 2023
SCALE:
AS NOTED

1 FOUNDATION PLAN
11x17 1/8" SCALE
24x36 1/4" SCALE

A/202



GENERAL NOTES

DO NOT SCALE DRAWINGS
ANY MISSING OR UNCLEAR DIMENSIONS TO BE REPORTED TO CTX FOR CLARIFICATION
REFER TO STRUCTURAL ENGINEER NOTES FOR ALL DRAWINGS
REFER TO MECHANICAL ENGINEERING PLANS FOR PLUMBING AND AIR CONDITIONING SYSTEMS INFORMATION
REFER TO ELECTRICAL ENGINEERING DRAWINGS FOR ELECTRICAL LAYOUT AND SYSTEM INFORMATION

ANY DEVIATION FROM PLANNING APPROVED DOCUMENTS REQUIRES THE SUBMISSION OF A PLANNING REVISION NO EXCEPTIONS

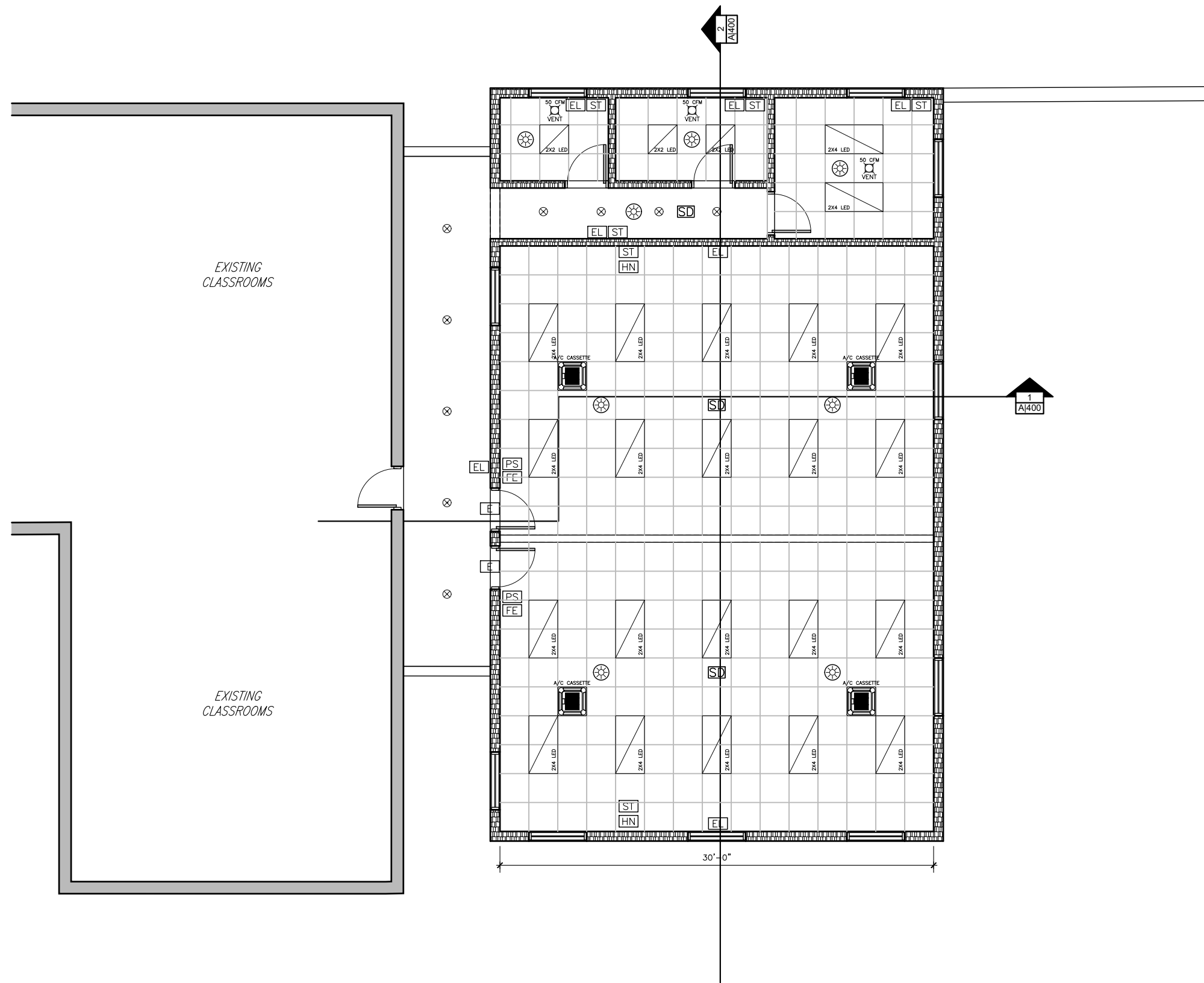

APR 26 2023

REVISIONS

FRANCIS PATTON

#191 NORTH SHORE BERMUDA

TECHNICIAN:
BMS
REF:
SDs 05450
DATE:
MAR 2023
SCALE:
AS NOTED

FIRE SAFETY SYSTEM NOTES

EXISTING STAIRS ARE SOLID NON COMBUSTIBLE CONSTRUCTION AND CONFORM TO BERMUDA COMMERCIAL BUILDING SPECIFICATIONS

ALL EXIT DOORS AND ALL DOORS AFFORDING A MEANS OF ACCESS THERETO SHALL BE FITTED WITH APPROVED EXIT FREE LOCKS. NO OTHER LOCKS, CATCHES, OR FASTENINGS SHALL BE FITTED. ALL ACCESS DOORS SHOULD BE HUNG TO OPEN IN LINE OF TRAVEL (OUTWARDS)

EXIT SIGNS WITH NOT LESS THAN 6" BLOCK LETTERS AND PRINCIPLE STROKES 3/4" WIDE ON A WHITE BACKGROUND SHOULD BE PROVIDED OVER ALL EXITS. DIRECTIONAL SIGNS WHERE NECESSARY SHOULD BE PROVIDED TO INDICATE THE DIRECTION OF TRAVEL TO REACH SUCH EXITS. THE SIGNS SHOULD BE ILLUMINATED BY BOTH THE GENERAL AND EMERGENCY LIGHTING SYSTEMS

TYPE 1 EMERGENCY (TRICKLE CHARGE) LIGHTING SHALL BE PROVIDED THROUGHOUT ALL EXIT WAYS INCLUDING STAIRWAYS WHERE APPLICABLE AND CONFORM TO THE REQUIREMENTS CONTAINED IN THE NATIONAL FIRE CODE No. 70. WIRING INSTALLATION OF THE EMERGENCY LIGHTING SYSTEM SHALL BE IN ACCORDANCE WITH THE NATIONAL FIRE CODE No. 70 (NFPA - NATIONAL ELECTRICAL CODE). UPON COMPLETION OF THE INSTALLATION, A CERTIFICATE SHOULD BE OBTAINED FROM A COMPETENT INSTALLATION ENGINEER STATING THAT THE EMERGENCY LIGHTING SYSTEM WILL PROVIDE SATISFACTORY ILLUMINATION FOR A PERIOD OF 90 MIN. IN THE EVENT OF FAILURE OR DISCONNECTION OF THE MAIN LIGHTING SYSTEM AND THAT THE INSTALLATION COMPLIES WITH NATIONAL FIRE CODE No. 70

MANUAL PULL STATIONS SHALL BE PROVIDED AT OR NEAR EACH EXIT OR LANDING. THE SYSTEM SHALL ALSO INCORPORATE THERMAL AND SMOKE DETECTOR UNITS THROUGHOUT

THE THERMAL AND SMOKE DETECTOR UNITS SHOULD ACTIVATE AN AUDIBLE ALARM THROUGHOUT THE ENTIRE PREMISES. THE AUDIBLE ALARM SYSTEM SHOULD BE OF SUCH CHARACTER AND SO DISTRIBUTED AS TO BE EFFECTIVELY HEARD ABOVE ALL OTHER SOUNDS IN EVERY ROOM IN THE PREMISES. THE DEVICE SHOULD BE A HORN/SROBE WARNING DEVICE. IN ADDITION, AN EXTERNAL VISUAL (STROBE) SHOULD BE LOCATED ON THE OUTSIDE OF THE BUILDING AND SHOULD BE SEEN BY APPROACHING EMERGENCY VEHICLES. THE CONTROL AND INDICATING EQUIPMENT SHALL BE ACCOMMODATED IN AN AREA ON THE GROUND FLOOR AND IN THE IMMEDIATE VICINITY OF THE ENTRANCE TO THE BUILDING

THE DOORS OPENING INTO STAIRWAYS AND ENTRANCE VESTIBULE SHALL BE AN APPROVED SELF CLOSING, 90 MINUTE FIRE DOOR AND FRAME ASSEMBLY. ALL DOORS OPENING INTO THE EXIT CORRIDOR SHALL BE APPROVED SELF CLOSING ONE HOUR FIRE DOORS AND FRAME ASSEMBLIES

ALL SEPARATION WALLS SHOULD BE CONTINUOUS FROM SLAB TO SLAB AND SLAB TO ROOF AND SHOULD AFFORD NOT LESS THAN TWO (2) HOURS FIRE RESISTANCE BETWEEN UNITS

ALL STRUCTURAL STEEL TO HAVE MIN. TWO (2) HOUR FIRE PROTECTION. ROOF STRUCTURE TO HAVE MIN. ONE (1) HOUR FIRE PROTECTION

1 X 10 lbs GENERAL PURPOSE (DCP) FIRE EXTINGUISHER SHALL BE INSTALLED NEAR EACH EXIT ON EACH LANDING. EXTINGUISHERS SHOULD BE MOUNTED ON BRACKETS FIXED SECURELY TO THE WALL OR OTHER UPRIGHT STRUCTURE SO THAT THE TOP OF EACH ONE IS NOT MORE THAN 3'-6" ABOVE F.F.L.

BUILDING IS FITTED WITH AN EXISTING DRY RISING MAIN OF 4" MIN. DIAMETER FOR FIRE PROTECTION WITH OUTLETS AT ALL FLOOR LEVELS. EACH OUTLET HAS A 2-1/2" MALE OUTLET FITTED WITH A HAND CONTROLLED VALVE TO ENABLE THE FIRE SERVICE TO CONNECT HOSE TO BUILDING. THE DRY RISING MAIN IS PROVIDED WITH A SIAMESE FIRE DEPARTMENT PUMPER CONNECTION INLET OF 2 X 2-1/2" FEMALE SWIVEL COUPLINGS OF THE TYPE FITTED WITH CLAPPER VALVES AT EXTERIOR MAIN ENTRANCE AREA

EXISTING REMOTE FIRE ANNUNCIATOR PANEL AT EXISTING FRONT MAIN ENTRANCE.

EXISTING MAIN FIRE PANEL LOCATED IN EXISTING BASEMENT ELEC ROOM BELOW.

EXTERIOR STROBE AT ROADSIDE OF BUILDING ON GROUND FLOOR



GENERAL NOTES

DO NOT SCALE DRAWINGS
 ANY MISSING OR UNCLEAR DIMENSIONS TO BE REPORTED TO CTX FOR CLARIFICATION
 REFER TO STRUCTURAL ENGINEER NOTES FOR ALL DRAWINGS
 REFER TO MECHANICAL ENGINEERING PLANS FOR PLUMBING AND AIR CONDITIONING SYSTEMS INFORMATION
 REFER TO ELECTRICAL ENGINEERING DRAWINGS FOR ELECTRICAL LAYOUT AND SYSTEM INFORMATION

ANY DEVIATION FROM PLANNING APPROVED DOCUMENTS REQUIRES THE SUBMISSION OF A PLANNING REVISION NO EXCEPTIONS

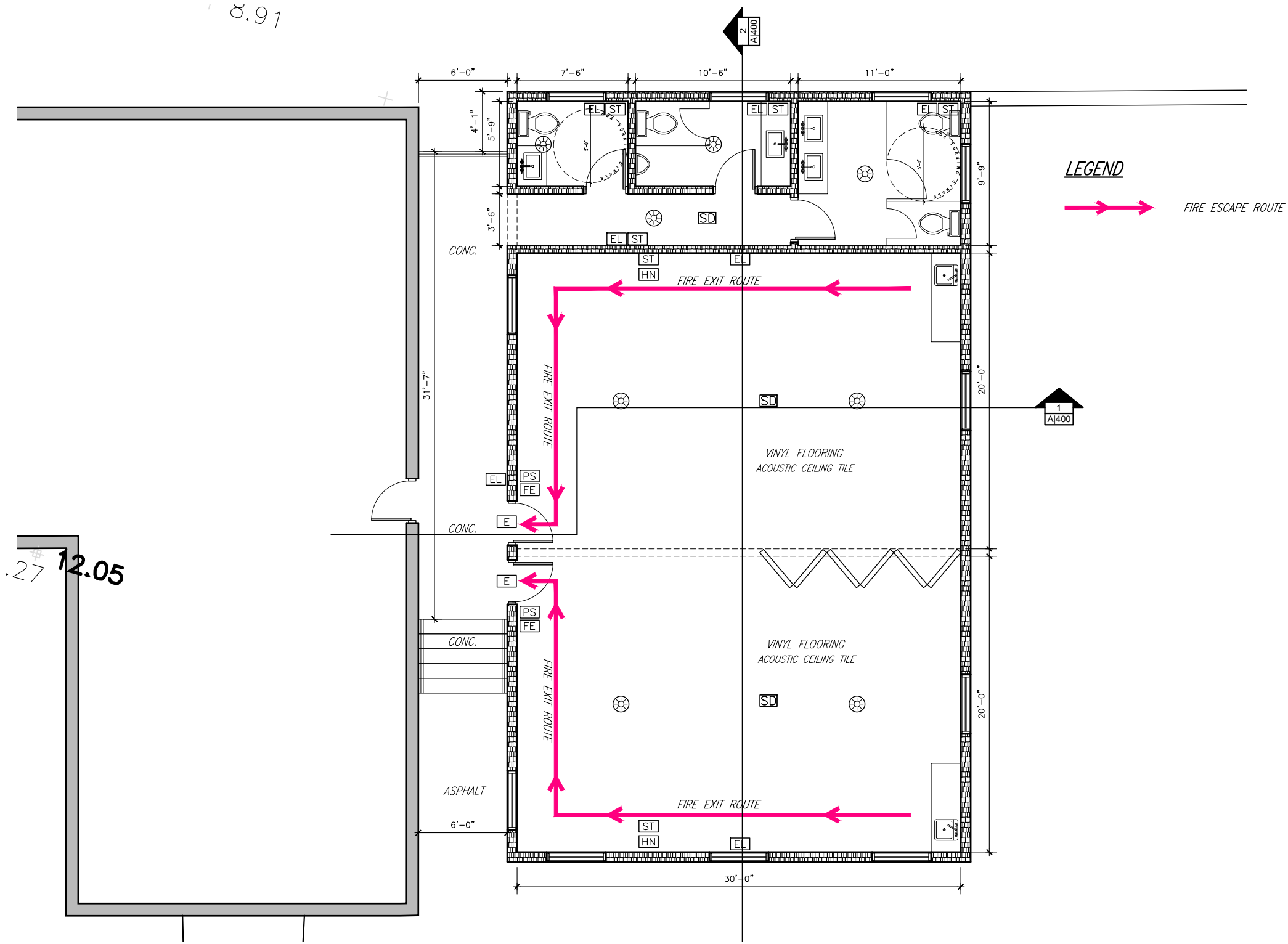

FIRE SAFETY SYSTEM LEGEND

FP	REMOTE ANNUNCIATOR PANEL
FE	FIRE EXTINGUISHER
PS	PULL STATION
EL	EMERGENCY LIGHT
E	EXIT SIGN
ST	STROBE LOCATION
HN	HORN LOCATION
SD	HARD WIRED SMOKE DETECTOR
HD	HARD WIRED HEAT DETECTOR

APR 26 2023

REVISIONS

FRANCIS PATTON

#191 NORTH SHORE BERMUDA

TECHNICIAN:
BMS
 REF:
SDs 05450
 DATE:
MAR 2023
 SCALE:
AS NOTED

A/202

GENERAL NOTES

DO NOT SCALE DRAWINGS
 ANY MISSING OR UNCLEAR DIMENSIONS TO BE REPORTED TO CTX FOR CLARIFICATION
 REFER TO STRUCTURAL ENGINEER NOTES FOR ALL DRAWINGS
 REFER TO MECHANICAL ENGINEERING PLANS FOR PLUMBING AND AIR CONDITIONING SYSTEMS INFORMATION
 REFER TO ELECTRICAL ENGINEERING DRAWINGS FOR ELECTRICAL LAYOUT AND SYSTEM INFORMATION

ANY DEVIATION FROM PLANNING APPROVED DOCUMENTS REQUIRES THE SUBMISSION OF A PLANNING REVISION NO EXCEPTIONS

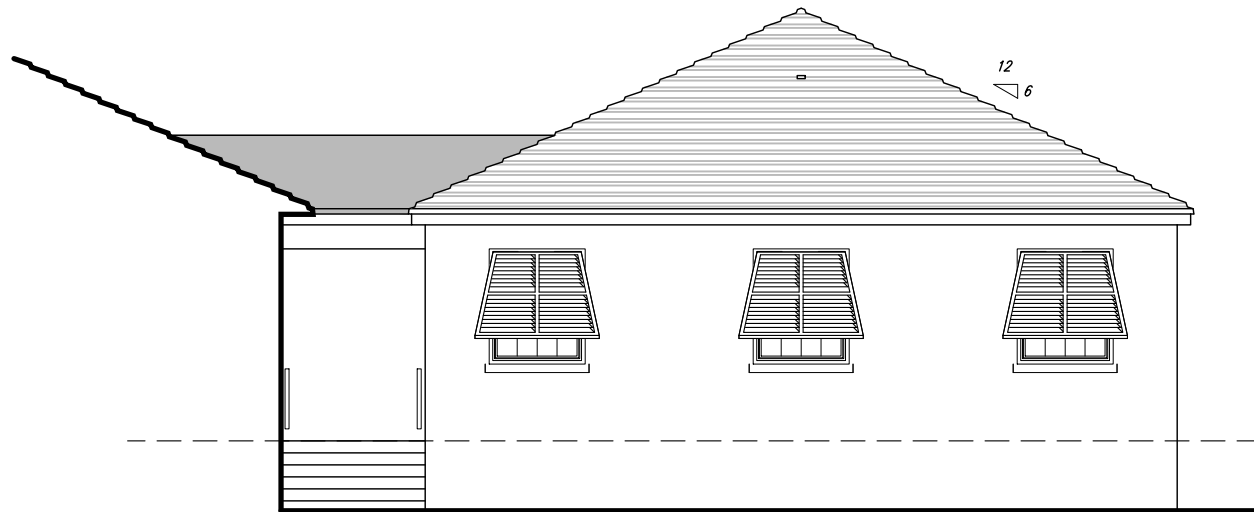

1 SOUTH ELEVATION
 11x17 3/16" SCALE
 24x36 3/8" SCALE

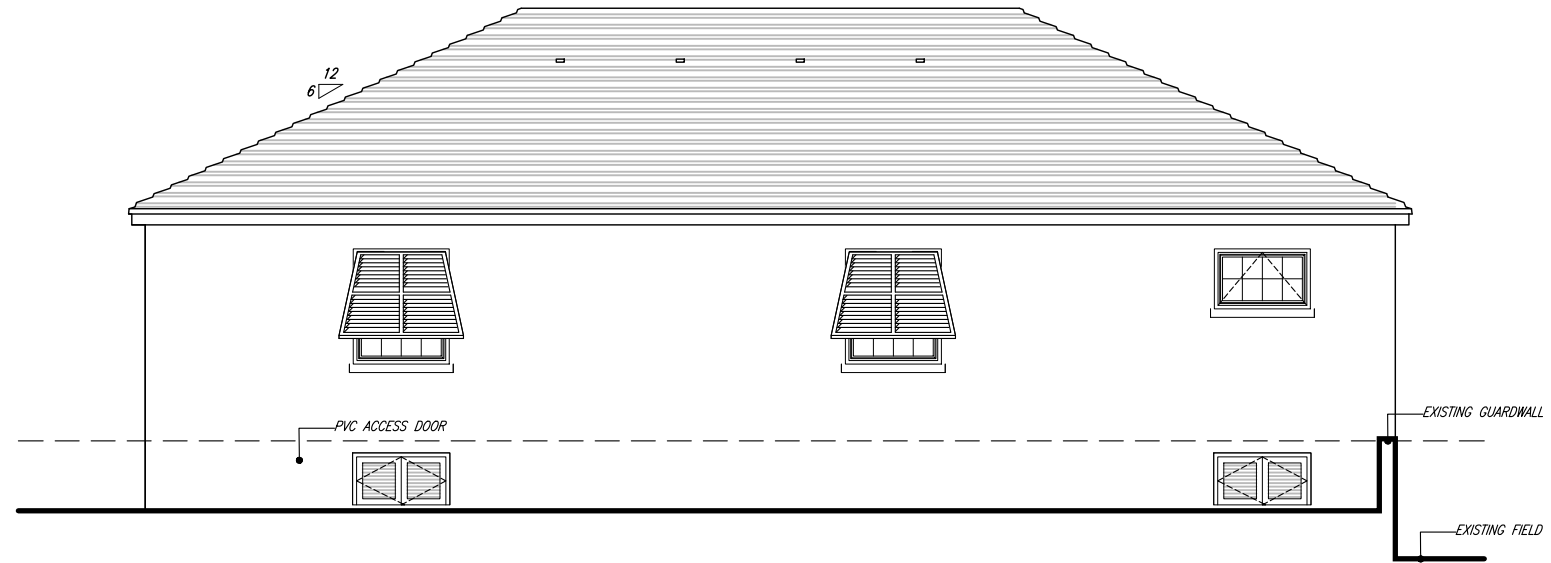

2 EAST ELEVATION
 11x17 3/16" SCALE
 24x36 3/8" SCALE

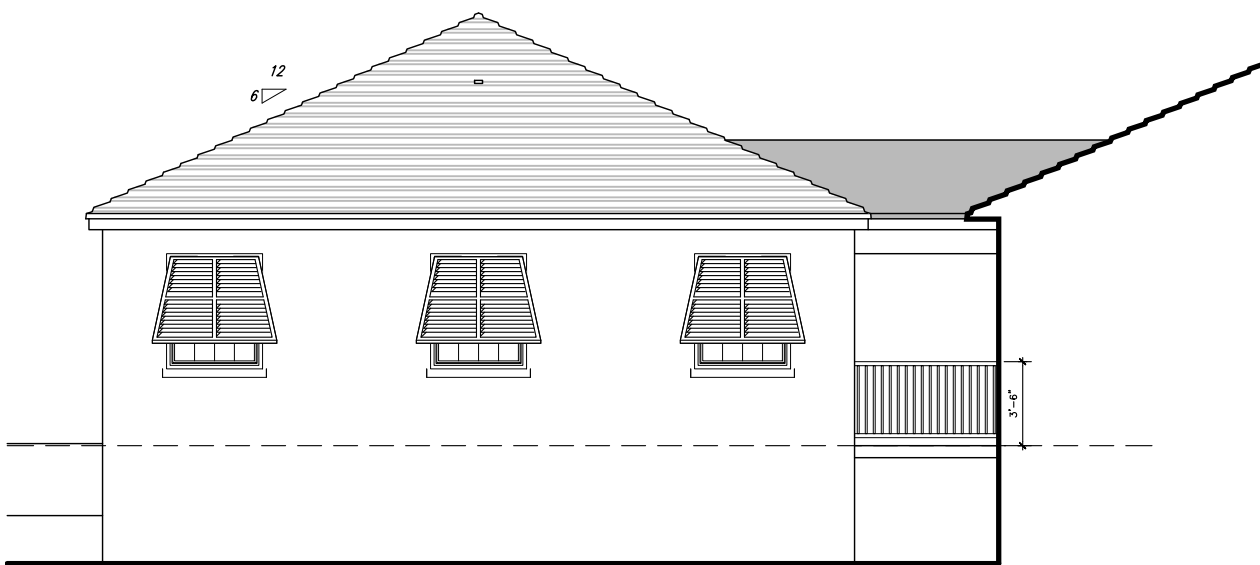

3 NORTH ELEVATION
 11x17 3/16" SCALE
 24x36 3/8" SCALE

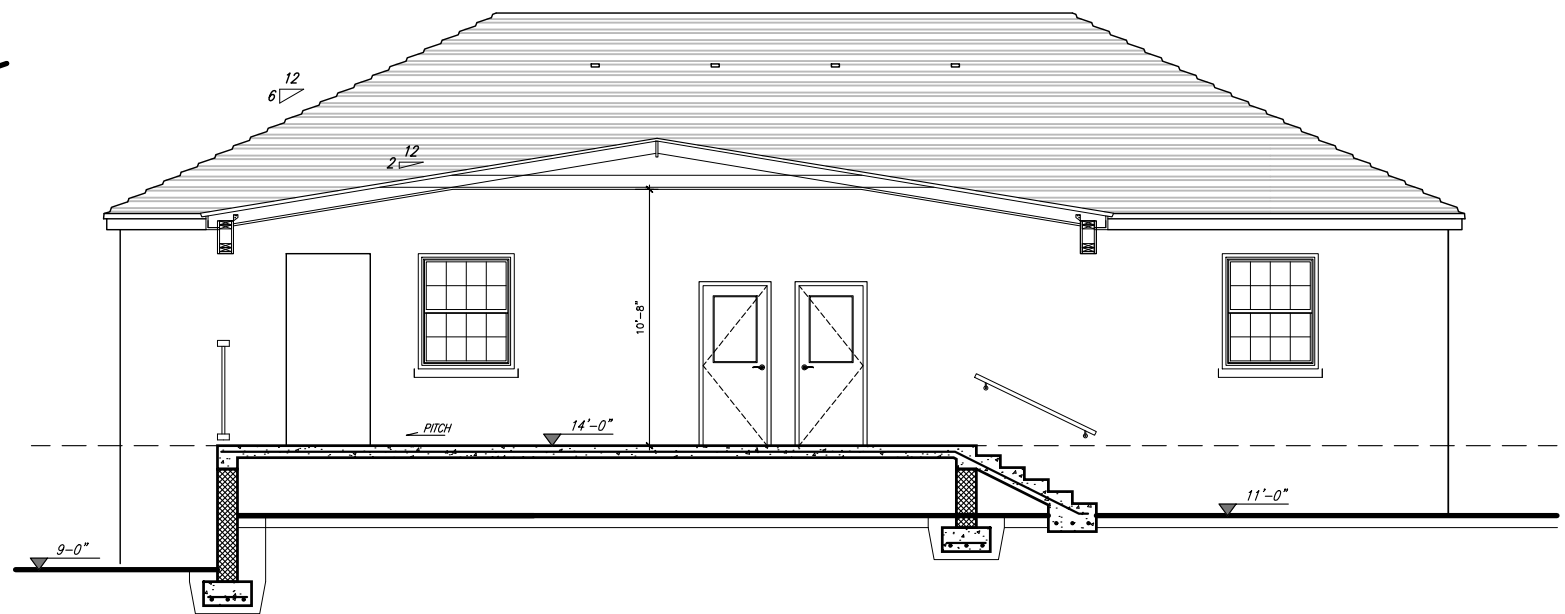

4 WEST ELEVATION
 11x17 3/16" SCALE
 24x36 3/8" SCALE

APR 26 2023

REVISIONS

FRANCIS PATTON

#191 NORTH SHORE BERMUDA

TECHNICIAN:

BMS

REF: SDs 05450

DATE: MAR 2023

SCALE: AS NOTED

GENERAL NOTES

DO NOT SCALE DRAWINGS
 ANY MISSING OR UNCLEAR DIMENSIONS TO BE REPORTED TO CTX FOR CLARIFICATION
 REFER TO STRUCTURAL ENGINEER NOTES FOR ALL DRAWINGS
 REFER TO MECHANICAL ENGINEERING PLANS FOR PLUMBING AND AIR CONDITIONING SYSTEMS INFORMATION
 REFER TO ELECTRICAL ENGINEERING DRAWINGS FOR ELECTRICAL LAYOUT AND SYSTEM INFORMATION

ANY DEVIATION FROM PLANNING APPROVED DOCUMENTS REQUIRES THE SUBMISSION OF A PLANNING REVISION NO EXCEPTIONS

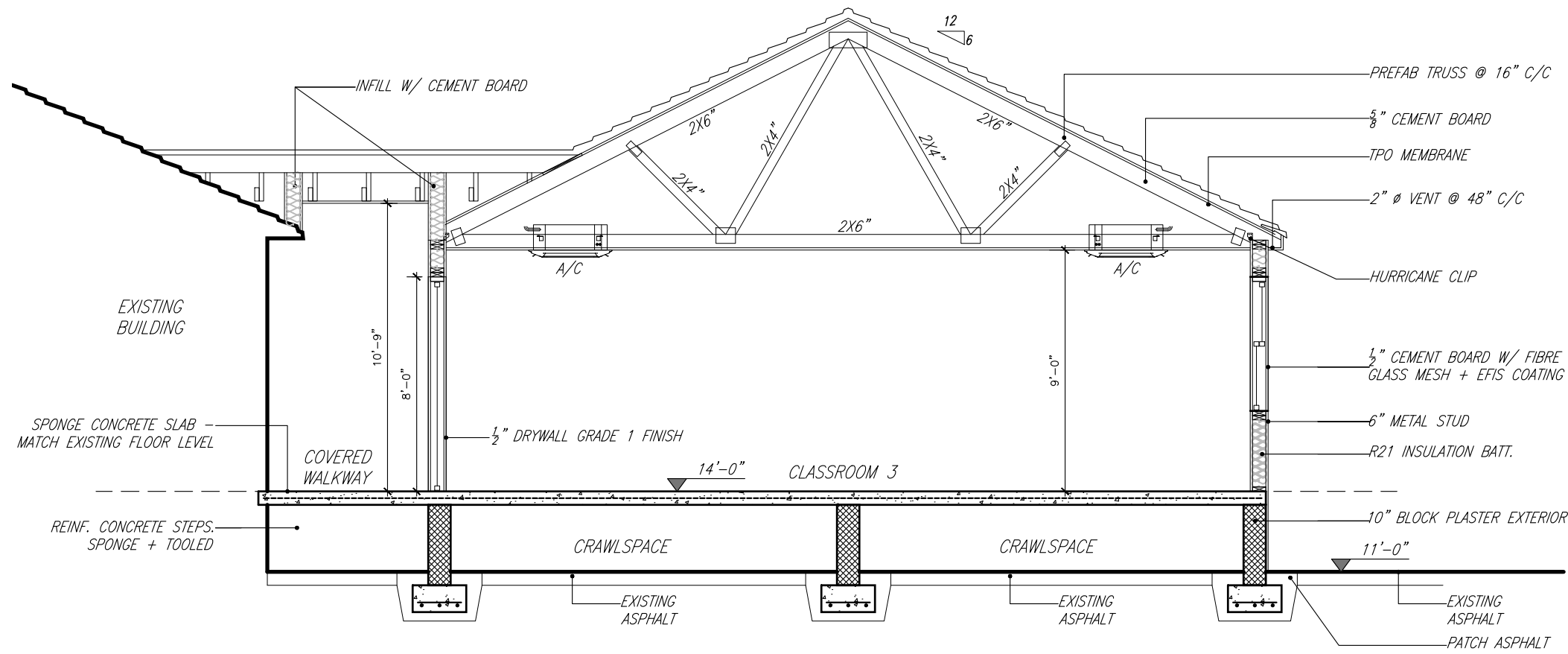

1 BUILDING SECTION 1
 11x17 3/16" SCALE
 24x36 3/8" SCALE

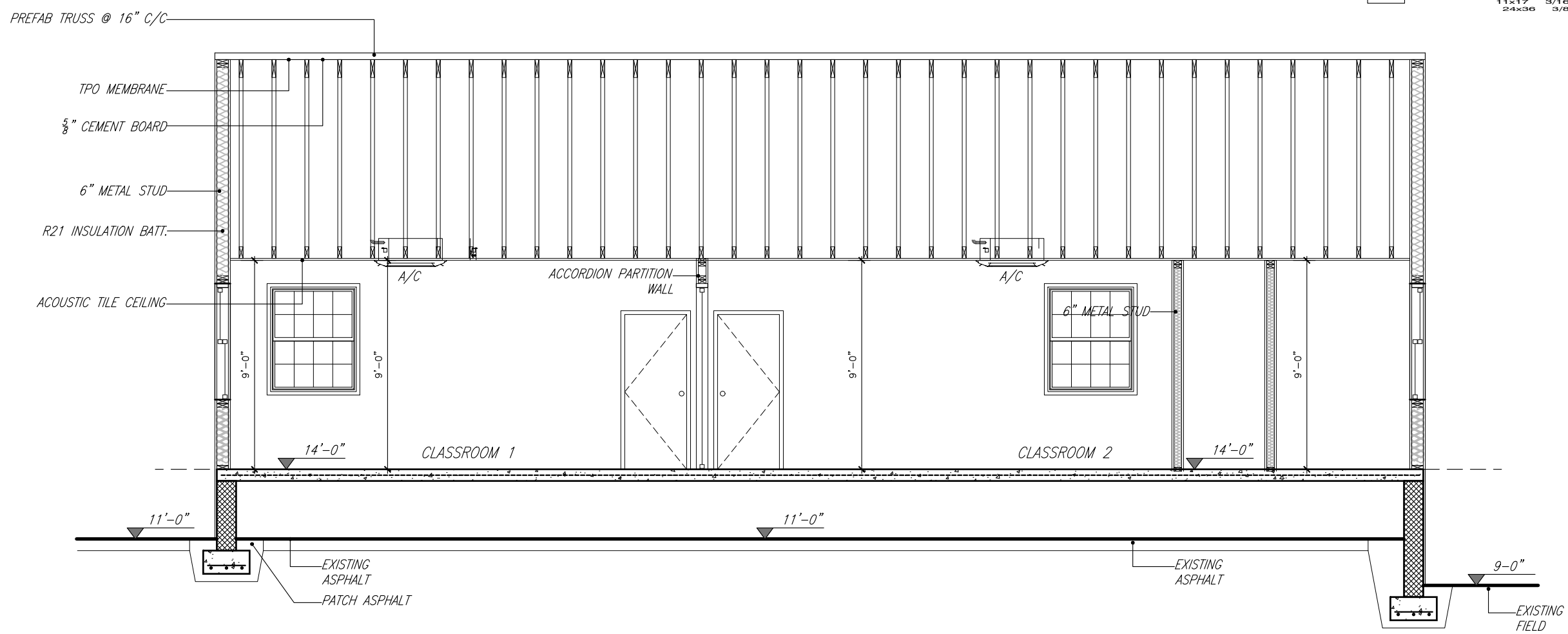

2 BUILDING SECTION 2
 11x17 3/16" SCALE
 24x36 3/8" SCALE

APR 26 2023
REVISIONS

FRANCIS PATTON
 #191 NORTH SHORE BERMUDA

TECHNICAL: BMS
 REF: SDs 05450
 DATE: MAR 2023
 SCALE: AS NOTED

GENERAL NOTES

DO NOT SCALE DRAWINGS
 ANY MISSING OR UNCLEAR DIMENSIONS TO BE REPORTED TO CTX FOR CLARIFICATION
 REFER TO STRUCTURAL ENGINEER NOTES FOR ALL DRAWINGS
 REFER TO MECHANICAL ENGINEERING PLANS FOR PLUMBING AND AIR CONDITIONING SYSTEMS INFORMATION
 REFER TO ELECTRICAL ENGINEERING DRAWINGS FOR ELECTRICAL LAYOUT AND SYSTEM INFORMATION

ANY DEVIATION FROM PLANNING APPROVED DOCUMENTS REQUIRES THE SUBMISSION OF A PLANNING REVISION
 NO EXCEPTIONS

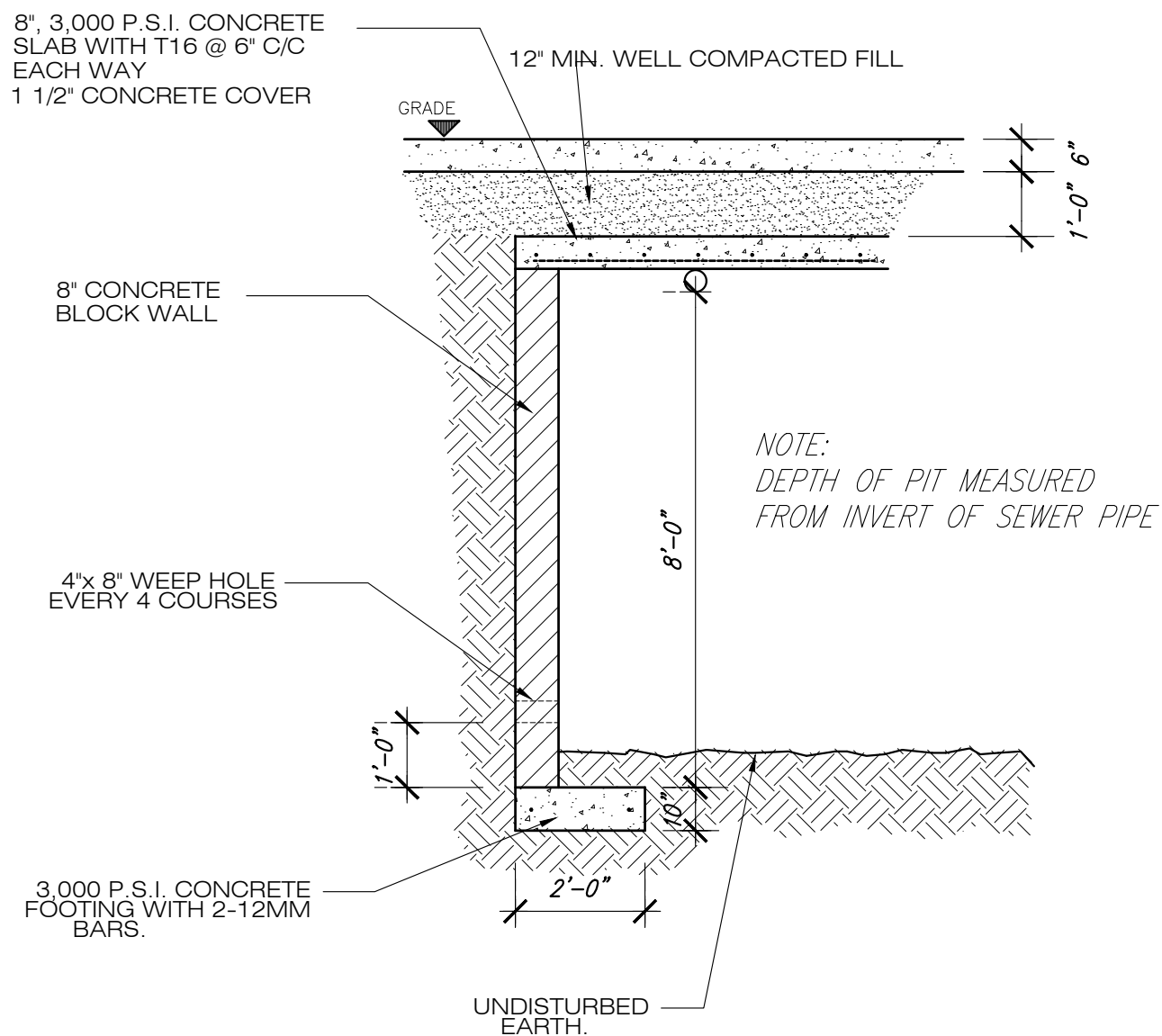

CESS PIT SECTION DETAIL

NOTE:

BATHROOM WASTE (4" PVC) TO ENTER BATHROOM CHAMBER VIA RUNNING TRAP.

KITCHEN / LAUNDRY WASTE TO PIT IN 3" PVC. VENTED TRAP AT SOURCE. PLACE VENT PIPE IN DISCRETE LOCATION TO BE APPROVED BY CLIENT.

CESSPIT TO BE LOCATED AS FOLLOWS:

BOUNDARY 10' MIN, BUILDING 10' MIN, POOL 20' MIN, TANK 20' MIN.

UNLESS OTHERWISE APPROVED. RUN WASTE PIPES SHORTEST ROUTE POSSIBLE. MAINTAIN ALL REGULATIONS BRBC 2014

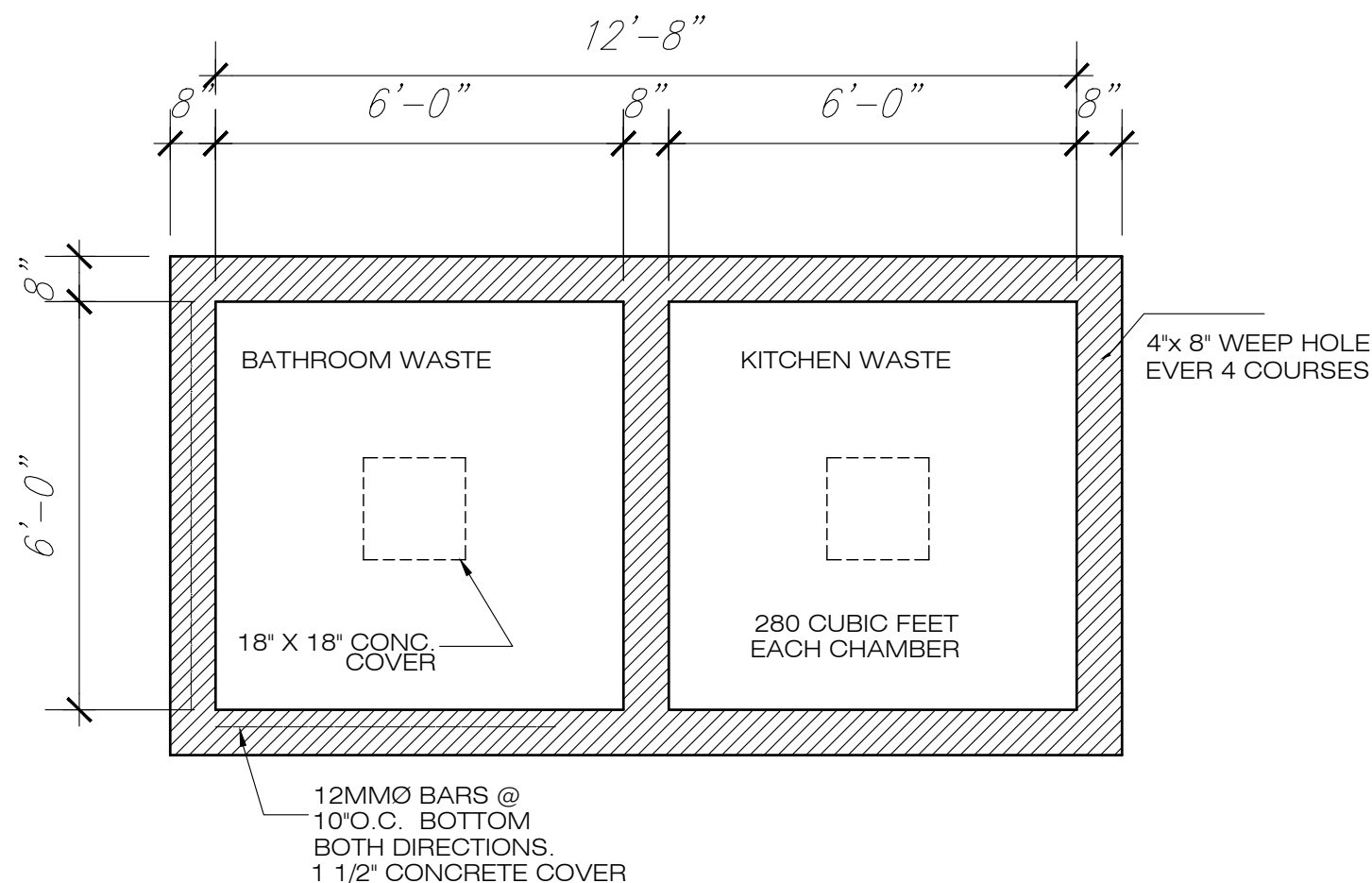

CESS PIT PLAN DETAIL

APR 26 2023

REVISIONS

FRANCIS PATTON

#191 NORTH SHORE BERMUDA

TECHNICIAN:

BMS

REF:

SDs 05450

DATE:

MAR 2023

SCALE:

AS NOTED

BACKFILL MATERIAL

- 1. BACKFILL MATERIAL SHALL BE FREE FROM ORGANIC MATTER, CONSTRUCTION DEBRIS AND LARGE ROCKS (GREATER THAN 3"(THREE INCHES)).
- 2. DO NOT BACKFILL AGAINST WALLS RETAINING EARTH UNTIL ELEMENTS PROVIDING LATERAL SUPPORT ARE COMPLETED.

DEMOLITION, EXCAVATION AND EARTHWORK

- 3. REMOVE EXISTING CONSTRUCTION AS INDICATED ON THE DRAWINGS. TAKE NECESSARY PRECAUTIONS TO SUPPORT THE STRUCTURE THAT IS TO REMAIN AND DISPOSE PROMPTLY OF MATERIALS FROM DEMOLITION OPERATIONS.
- 4. CARE SHALL BE TAKEN DURING DEMOLITION OF THE EXISTING BUILDING SO AS NOT TO UNDULY DISTURB ANY PART OF THE EXISTING STRUCTURE THAT IS TO REMAIN.

- 6. ALL ROCK CUTS GREATER THAN 6' (SIX FEET) IN HEIGHT SHALL BE CERTIFIED BY A REGISTERED STRUCTURAL ENGINEER.

- 7. BACKFILL MATERIAL SHALL BE FREE FROM ORGANIC MATTER, CONSTRUCTION DEBRIS AND LARGE ROCKS (GREATER THAN 3"(THREE INCHES)).

- 8. DO NOT BACKFILL AGAINST WALLS RETAINING EARTH UNTIL ELEMENTS PROVIDING LATERAL SUPPORT ARE COMPLETED.

FOUNDATIONS

- 9. ALL FOOTING AND FOUNDATIONS TO BEAR ON UNDISTURBED SOUND ROCK. BEARING MATERIAL IS TO REMAIN UNDISTURBED AND BE REVIEWED BY THE ENGINEER PRIOR TO PLACING CONCRETE FOR FOOTING AND FOUNDATIONS.
- 10. PROVIDE 2" CONCRETE BLINDING TO FOUNDATIONS PLACED ON COMPACTED SAND.
- 11. ALL SHORING, SHEETING, AND DEWATERING SHALL BE THE RESPONSIBILITY OF THE CONTRACTOR.

CONCRETE

- 14. EXPERIENCED PERSONNEL TO THE SATISFACTION OF THE ENGINEER SHALL MECHANICALLY VIBRATE ALL STRUCTURAL CONCRETE IN THE APPROVED MANNER.
- 15. NO SPLICES OF REINFORCEMENT SHALL BE PERMITTED EXCEPT AS DETAILED OR AUTHORIZED BY THE STRUCTURAL ENGINEER.
- 16. WHEN INSTALLING EXPANSION BOLTS OR ADHESIVE ANCHORS, TAKE MEASURES TO AVOID DRILLING OR CUTTING OF ANY EXISTING REINFORCING AND DESTRUCTION OF CONCRETE.
- 17. CONCRETE SLABS SHALL BE FINISHED FLAT AND LEVEL WITHIN TOLERANCE TO THE ELEVATION INDICATED ON THE DRAWINGS.

- 20. CONCRETE SHALL BE MECHANICALLY COMPACTED IN AN APPROVED MANNER.
- 21. CEMENT: ASTM C150; TYPE I - CAN3-A23.1, TYPE 10
- 22. AGGREGATES: ASTM C33 NORMAL WEIGHT.
- 23. STRUCTURAL CONCRETE SHALL ACHIEVE A MINIMUM CUBE COMPRESSIVE STRENGTH AT 28 DAYS AS FOLLOWS UNLESS NOTED OTHERWISE.

- 24. CONCRETE COVER TO BARS SHALL BE AS FOLLOWS, UNLESS NOTED OTHERWISE:
 - 3" FOR CONCRETE CAST AGAINST AND PERMANENTLY EXPOSED TO EARTH. FOUNDATIONS, RETAINING WALLS.
 - 2" FOR CONCRETE EXPOSED TO WEATHER.
 - 1 1/2" FOR CONCRETE NOT EXPOSED TO WEATHER OR IN CONTACT WITH GROUND. SLABS, WALLS, BEAMS, COLUMNS.

REINFORCING STEEL

- 25. ALL STEEL BARS SHALL BE GALVANIZED WITH A MINIMUM YIELD STRESS OF 60,000 PSI UNLESS NOTED OTHERWISE.
- 26. UNLESS NOTED OTHERWISE, MINIMUM ALLOWABLE LAP LENGTHS TO REBAR SHALL BE:
 - T6 = 12" (TWELVE INCHES)
 - T8 = 15" (FIFTEEN INCHES)
 - T10 = 18" (EIGHTEEN INCHES)
 - T12 = 24" (TWENTY FOUR INCHES)
 - T16 = 32" (THIRTY TWO INCHES)
 - T20 = 40" (FORTY INCHES)
 - T25 = 60" (SIXTY INCHES)
 - WIRE MESH = 12" (TWELVE INCHES)
- 27. LOCATION OF ALL LAPS SHALL BE SHOWN ON REINFORCEMENT STEEL SHOP DRAWINGS AND SHALL BE APPROVED BY THE STRUCTURAL ENGINEER.
- 28. REBAR SHALL CONFORM TO ASTM-767 GRADE 60 CALV. WELDED WIRE FABRIC (MESH) SHALL CONFORM TO ASTM-A-185.

MASONRY WALLS

- 29. THE AVERAGE COMPRESSIVE STRENGTH OF MASONRY UNITS SHALL BE 2000 PSI BASED ON THE NET AREA OF THE BLOCK CELL. MASONRY UNITS SHALL CONFORM TO ASTM C90. ALL BLOCKWORK SHALL BE LAYED IN RUNNING BOND U.N.O.
- 30. MORTAR SHALL BE 'TYPE S' IN ACCORDANCE WITH ASTM C270.
- 31. GROUT FOR MASONRY UNITS SHALL BE 3000 PSI CONCRETE WITH AN 8" SLUMP.
- 32. FILLED BLOCK WALLS SHALL BE CONSTRUCTED IN A MAXIMUM OF FIVE COURSE LIFTS. CONCRETE TO BE STOPPED 2" FROM THE TOP OF THE BLOCK TO ALLOW THE NEXT LIFT TO KEY TOGETHER. ENSURE ADEQUATE LAP LENGTH OF VERTICAL REINFORCING IS OBTAINED PRIOR TO FILLING BLOCKS.
- 33. ALL OPENINGS IN MASONRY WALLS ARE TO BE SPANNED BY REINFORCED CONCRETE LINTELS.
- 34. MINIMUM BEARING OF REINFORCED CONCRETE LINTELS AND BEAMS ONTO BLOCK WALLS SHALL BE 8" U.N.O.
- 35. ALL LAP SPLICES IN BLOCKWORK REINFORCING SHALL BE AS NOTED IN REINFORCING STEEL NOTES.
- 36. BLOCKWALLS BUTTING UP TO CONCRETE PIERS OR COLUMN ENCASUREMENTS SHALL BE TOOTHED EVERY 2ND COURSE WITH 8' KEY INTO BLOCKWORK WALL.
- 37. BLOCKWALLS BUTTING UP TO STEEL FRAMEWORK SHALL BE BONDED EVERY SECOND COURSE WITH APPROVED MECHANICAL FASTNERS.
- 38. UNLESS NOTED OTHERWISE ALL MASONRY WALLS REQUIRING REINFORCEMENT TO CONSIST OF EITHER:
 - A.) 2-T6 BARS @ 16" C/C OR EVERY SECOND COURSE WITH 1/2" MIN. COVER FROM THE OUTSIDE OF THE BLOCKS.
 - B.) 'DUR-O-WALL' TRUSS TYPE REINFORCING NUMBER 9 GAUGE, GALVANIZED WIRE (OR EQUIVALENT BRICK FORCE MESH), HORIZONTAL REINFORCING IS TO BE PLACED AT 16" C/C (EVERY SECOND COURSE) U.N.O.
- 39. ALL WALLS ARE TO RECEIVE A BOND BEAM ON TOP AT FLOOR LEVEL. BOND BEAMS ARE TO BE WIDTH OF WALL WIDE x 8" DEEP REINFORCED WITH 2T12 BARS CONTINUOUS. BOND BEAM REINFORCING IS TO BE EXTENDED INTO AND BE CONTINUOUS WITH ALL INTERSECTING BOND BEAMS. WHERE BOND BEAMS BUTT UP TO STEEL COLUMNS OR BEAMS, 6"x6"x5/16" ANGLE x 6" LONG IS TO BE WELDED TO THE STEEL MEMBER AND ENCASED IN THE BEAM.

LINELS

- 40. CONCRETE LINTEL BEAMS (3000 PSI) SHALL BE PROVIDED TO ALL OPENINGS IN ACCORDANCE WITH THE STRUCTURAL SCHEDULE.
- 41. MINIMUM BEARING OF LINTEL BEAMS SHALL BE 12" (TWELVE INCHES), UNLESS NOTED OTHERWISE.
- 42. WHERE THE LINTEL BUTTS UP TO A STEEL COLUMN, A 6" x 6" x 5/16" ANGLE x 6" LONG SHALL BE WELDED TO THE COLUMN WITH 1/4" FILLET WELD ALL AROUND IN ORDER TO PROVIDE A SHELF TO SUPPORT THE LINTEL.
- 43. CONTRACTOR TO PROVIDE 24 HOURS NOTICE FOR THE INSPECTION OF ALL REINFORCEMENT, INCLUDING MASONRY REINFORCEMENT PRIOR TO PLACING CONCRETE.
- 44. CONCRETE TO BE TESTED BASED ON SPECIFICATION REQUIREMENTS. TESTING TO BE DONE BY AN APPROVED TESTING AGENCY.

INSPECTION AND TESTING

- 45. CONTRACTOR TO PROVIDE 24 HOURS NOTICE FOR THE INSPECTION OF ALL REINFORCEMENT, INCLUDING MASONRY REINFORCEMENT PRIOR TO PLACING CONCRETE.
- 44. CONCRETE TO BE TESTED BASED ON SPECIFICATION REQUIREMENTS. TESTING TO BE DONE BY AN APPROVED TESTING AGENCY.

DESIGN NOTES:

- 45. DESIGN CODES: STRUCTURAL DESIGN IS IN ACCORDANCE WITH BERMUDA BUILDING CODE 1998, WHICH REFERENCES THE BOCA NATIONAL BUILDING CODE.
- 46. DESIGN DATA:
 - GRAVITY LIVE LOADS
 - ROOF: 30 PSF
 - TYPICAL FLOOR: 85 PSF
 - STAIRS: 100 PSF
 - BALCONY: 60 PSF
 - LATERAL LOADS - WIND (PER ASCE 7.05)
 - BASIC WIND SPEED (3 SEC GUST): 150 MPH
 - EXPOSURE: C
 - IMPORTANCE FACTOR (I): 1.15

WALL SCHEDULE

Table with columns TYPE and DETAILS. Includes 10" HOLLOW CONCRETE BLOCK WALL, 10" THK BLOCK FOUNDATION WALL FILLED WITH 3000 PSI CONCRETE, and 8" THK HOLLOW CONCRETE BLOCK WALL.

WALL NOTES

- 1. BLOCKWORK WALLS THAT ARE BELOW GRADE AND CELLS THAT ARE REINFORCED ARE TO BE SOLID FILLED WITH 3000psi CONCRETE. CELLS ARE TO BE CLEANED OUT PRIOR TO FILLING.
- 2. CONCRETE FILL TO BE PLACED IN MAXIMUM OF 4'-0" HIGH LIFTS WITH THE POUR STOPPING 2" BELOW THE TOP OF THE BLOCK CELL TO ALLOW THE NEXT LIFT TO KEY TOGETHER.
- 3. CONCRETE WALLS TO BE PLACED IN CONTINUOUS OPERATIONS TO AVOID COLD JOINTS.

FOUNDATION SCHEDULE

Table with columns TYPE and DETAILS. Includes F1 2'-0" WIDE x 12" DEEP CONCRETE STRIP FOOTING REINFORCED WITH 3-T12 LONGITUDINAL REBARS AND T12 @ 12" % TRANSVERSE REBARS (3" CONCRETE COVER).

FOUNDATION NOTES

- 1. ALL FOUNDATION TO BEAR ON UNDISTURBED BEDROCK. CONTACT REGISTERED ENGINEER IF CONDITIONS ARE DIFFERENT.
- 2. TAKE FOOTINGS DOWN TO BEDROCK AND THEN CONSTRUCT BACK UP TO UNDERSIDE OF SLAB LEVEL WITH SOLID FILLED BLOCKWORK WALLS.
- 3. CAST STARTER BARS INTO FOOTINGS TO MATCH VERTICAL WALL OR COLUMN STEEL, 12" HORIZONTAL LEGS, VERTICAL LEG LENGTH AS NECESSARY TO MEET MINIMUM LAP LENGTH AS PER TABLE.
- 4. COVER TO FOOTING STEEL TO BE 3"
- 5. AT ALL INTERSECTIONS AND CORNERS OF FOOTINGS, INSTALL 2-T16 'L' BARS WITH 36" LEGS

SLAB SCHEDULE

Table with columns TYPE and DETAILS. Includes S1 6" THK. SUSPENDED SLAB REINFORCED WITH T12 @ 8" C/C IN THE SHORT SPAN OF SLAB AND T12 @ 12" TRANSVERSE BARS (1/2" FROM BTM).

SLAB NOTES

- 1. CONSTRUCTION JOINTS IN SLABS TO BE KEPT TO A MINIMUM AND WHERE NECESSARY BE CENTERED OVER BEAMS AND ARE TO BE SQUARE AND VERTICAL. REINFORCEMENT TO BE CONTINUED THROUGH JOINTS A MINIMUM LAP LENGTH.
- 2. SLABS ARE TO BE CURED FOR A MINIMUM OF 7 DAYS BY KEEPING CONTINUOUSLY MOIST.
- 3. SLABS AND REINFORCING TO BEAR A MINIMUM OF 4" ONTO NEW BEAMS, 4" ONTO BLOCKWORK WALLS, OR 6" ONTO BERMUDA STONE WALLS.
- 4. EXTERIOR SLABS TO BE LAID TO FALLS AWAY FROM BUILDING WITH A MINIMUM SLOPE OF 2% . THICKNESS SHOWN IN TABLES IS MINIMUM DEPTH OF SLAB. INCREASE AS NECESSARY TO ACHIEVE THE DESIRED FALLS.

CONCRETE LINTEL SCHEDULE

Table with columns TYPE, SPAN, WxD, REINFORCEMENT, and TIES. Includes L-1, L-2, and BB-1 lintel types.

LINTEL NOTES

- 1. * TYPICAL LINTELS WHERE NOT OTHERWISE INDICATED.
- 2. ALL LINTEL TYPES SHOWN INDICATE LINTEL ABOVE FLOOR LEVEL.
- 3. ENSURE THAT EXISTING WALLS, FLOORS, AND ROOFS ARE SECURELY PROPPED PRIOR TO DEMOLITION OPERATIONS AND INSTALLATION OF BEAMS.
- 4. ABBREVIATIONS; NOI: NOT OTHERWISE INDICATED, WWO: WIDTH OF WALL IN WIDTH, UNO: UNLESS NOTED OTHERWISE
- 5. CONCRETE BEAMS AND LINTELS ARE TO HAVE A MAXIMUM OF 8" BEARING EITHER SIDE. REINFORCING IS TO CONTINUE A MINIMUM OF 6" OVER SUPPORTS. AT CORNERS AND INTERSECTIONS, HOOK BARS 36".
- 6. BLOCK CELLS BELOW EACH END OF BEAMS AND LINTELS ARE TO BE SOLID FILLED DOWN TO SLAB LEVEL.
- 7. WHEN POURING BELT BEAM, ALLOW CONCRETE TO EXTEND A MINIMUM OF 4" DOWN INTO BLOCK CELLS BELOW.

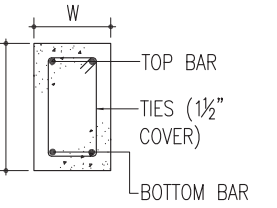

CONCRETE STAIR SCHEDULE

Table with columns TYPE and DETAILS. Includes SS1 6" THICK MIN. WAIST. WIDTH AS NOTED ON ARCHITECTURAL DRAWINGS.

STAIR NOTES

- 1. CONCRETE STAIRS ARE TO BE CURED FOR A MINIMUM OF 7 DAYS BY KEEPING CONTINUOUSLY MOIST
- 2. STAIRS, LANDING SLABS AND REINFORCING TO BEAR A MINIMUM OF 4" ONTO WALLS AND BEAMS
- 3. CONTINUE STAIR REINFORCING THROUGH LANDING SLABS

WALL STIFFNER SCHEDULE

Table with columns TYPE, SIZE, REINFORCEMENT, and TIES. Includes WS-1 8" x 16" 2-T12 (VERT. BARS) T6 @ 16" CTS.

WALL STIFFNER NOTES

- 1. ALL VERTICAL BARS TO HAVE 12" BEND INTO SLAB OR BEAM ABOVE AND SLAB/FOUNDATION BELOW.
- 2. BLOCKWORK COLUMNS TO BE POURED IN MAXIMUM 4' HIGH LIFTS WITH THE POUR STOPPING 2" BELOW THE TOP OF THE BLOCK CELL TO ALLOW THE NEXT LIFT TO KEY TOGETHER.

ROOF FRAMING SCHEDULE FOR SKB ROOF

Table with columns Type, Max. Span, Rafter Size and Spacing, Collar Tie Size and Spacing, Collar Tie Height 'X', and Rafter Connection. Includes R-1 31'-0" SEE SECTION 2/S2.1 1/2" DIA.

ROOF NOTES:

- 1. ALL ROOF PITCHES ARE TO MATCH EXISTING 7:12 SLOPE UNLESS STATED OTHERWISE.
- 2. SKB LAPPED PROFILE LIGHTWEIGHT ROOF SYSTEM, ON 5/8" PLYCEM BOARD FIXED DOWN TO RAFTERS WITH #12 x 2 1/2" LONG STAINLESS STEEL SCREWS @ 8" C/C EACH WAY.
- 3. TIMBER CONSTRUCTION SHALL CONFORM TO AITC. NATIONAL DESIGN SPECIFICATIONS AND BERMUDA BUILDING CODE (LATEST EDITION).
- 4. ALL TIMBER TO BE WOLMANIZED TYPE, PRESSURE TREATED.
- 5. ALL STEEL NUTS, BOLTS AND WASHERS ARE TO BE HOT DIP GALVANIZED CONFORMING TO ASTM A-325.
- 6. WALL PLATE 3"x4"
- 7. HIP RAFTERS: UNLESS OTHERWISE INDICATED ON PLAN SIZE AS COMMON RAFTERS (IN EXCESS OF 16'-0" LONG USE DOUBLE COMMON RAFTERS)
- 8. UNLESS NOTED OTHERWISE BOLT DOUBLE RAFTERS TOGETHER WITH 1/2"Ø. BOLTS AT 1'-4" C/C, BOLTS STAGGERED VERTICALLY.
- 9. RIDGE BOARDS 1"x8" FOR 6" RAFTERS, 1"x10" FOR 8" RAFTERS, AND 1"x12" FOR 10" OR 12" RAFTERS.
- 10. RIDGE POLE: FOR PEAK ROOFS 4"x4"
- 11. TIMBER STRINGERS: 2"x6" MIN. FIXED TO WALL WITH 3/8"Ø BOLTS AT 2'-6" C/C RAFTERS TO BE SIDE FIXED TO STRINGERS WITH JOIST HANGERS WHERE EXPOSED BELOW.
- 12. UNLESS NOTED OTHERWISE CRIPPLE BOARDS TO BE 1"x10" FOR 6" AND 8" RAFTERS, AND 1"x12" FOR 10" OR 12" RAFTERS.
- 13. UNLESS NOTED OTHERWISE FIX WALL PLATE TO BELT BEAM WITH 1/2"Ø BOLTS J BOLTS IN 3/8" DIA. HOLES THROUGH WALL PLATE AT 2'-6" C/C (BOLTS SET MIN. 6" INTO CONC. RING BEAM).
- 14. FIX EACH RAFTER TO WALL PLATE WITH FULLY NAILED 'SIMPSON STRONG TIE' HURRICANE CLIPS TYPE H2.5A PER RAFTER UNLESS NOTED OTHERWISE.
- 15. ALL NAILS FOR PERMANENT WORK TO BE GALVANIZED.
- 16. ALL BOLTS TO BE GALVANIZED STEEL OR STAINLESS STEEL.
- 17. EAVE SLATE: STANDARD PC CONC. UNITS FIXED W/ 2-NO. 2 1/2" NO.10 BRASS SCREWS.
- 18. RAINWATER GLIDES: 3"x4" STANDARD PC CONC. GUTTER STONES.
- 19. MINIMUM CLEARANCE OF TIMBER TO CHIMNEY: 1 1/2".



Table with columns DATE, NO., and REVISION. Includes MAY. 2023 and ISSUED TO CLIENT.



t: 441.297.6191 • info@brunel.bm • www.brunel.bm

PROJECT: FRANCIS PATTON PRIMARY SCHOOL #191 NORTH SHORE ROAD HAMILTON PARISH, BERMUDA

TITLE: GENERAL STRUCTURASL NOTES & SCHEDULES

Table with columns SCALE, AS SHOWN, JOB NO., 23-015, DRAWN BY: JC, DRAWING #: S.0, and DATE: MAY 2023.

DRAWING SCALE SHOWN IS FOR FULL-SIZE DRAWINGS. DRAWINGS PLOTTED ON 11"x17" SHEETS ARE HALF SCALE SHOWN (1/4"=1'-0" ON 24"x36" SHEET = 1/8"=1'-0" ON 11"x17" SHEET)

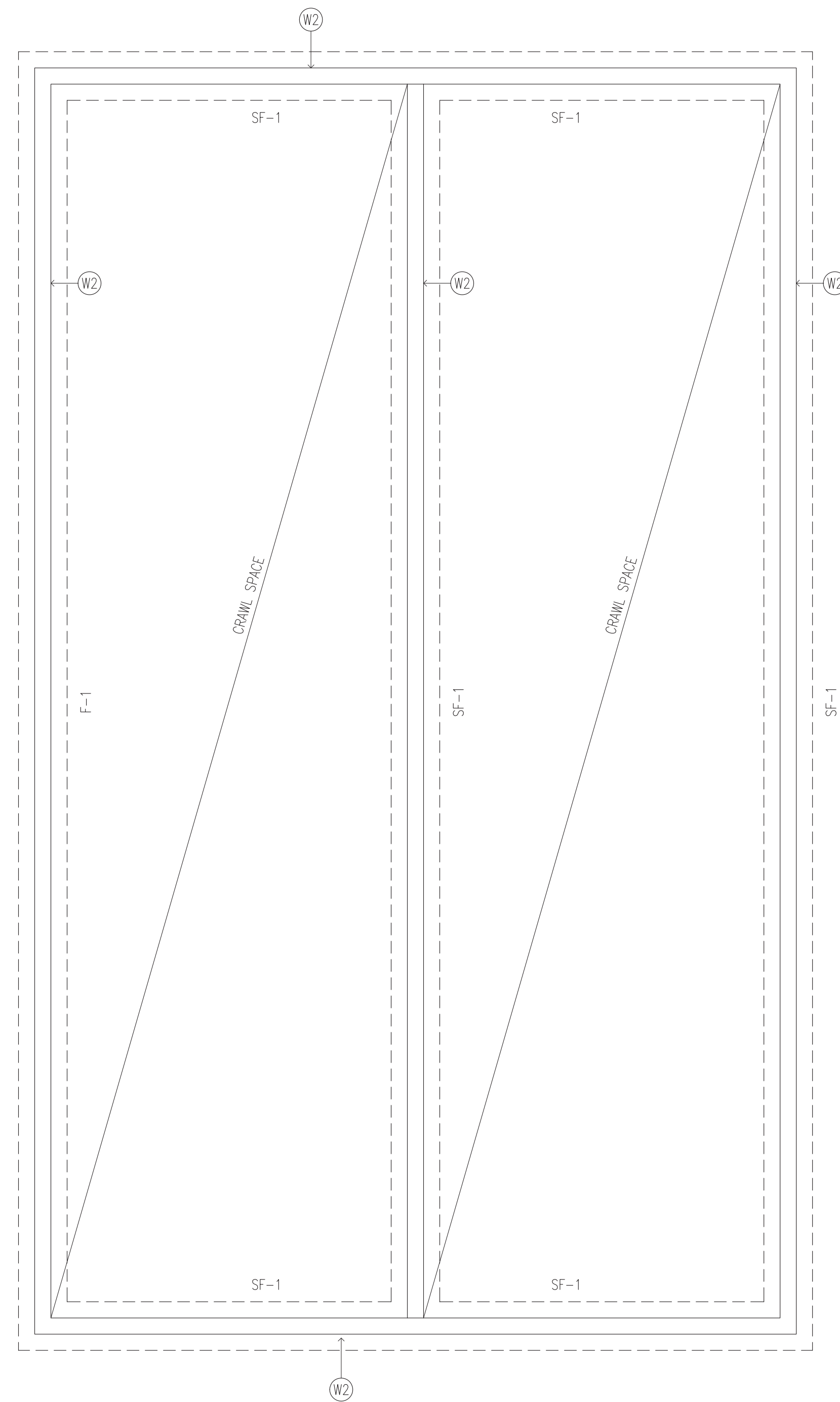

1 FOUNDATION FLOOR PLAN
 S1.1 SCALE: 1/8" = 1'-0" (11"x17" SHEET)
 1/4" = 1'-0" (24"x36" SHEET)

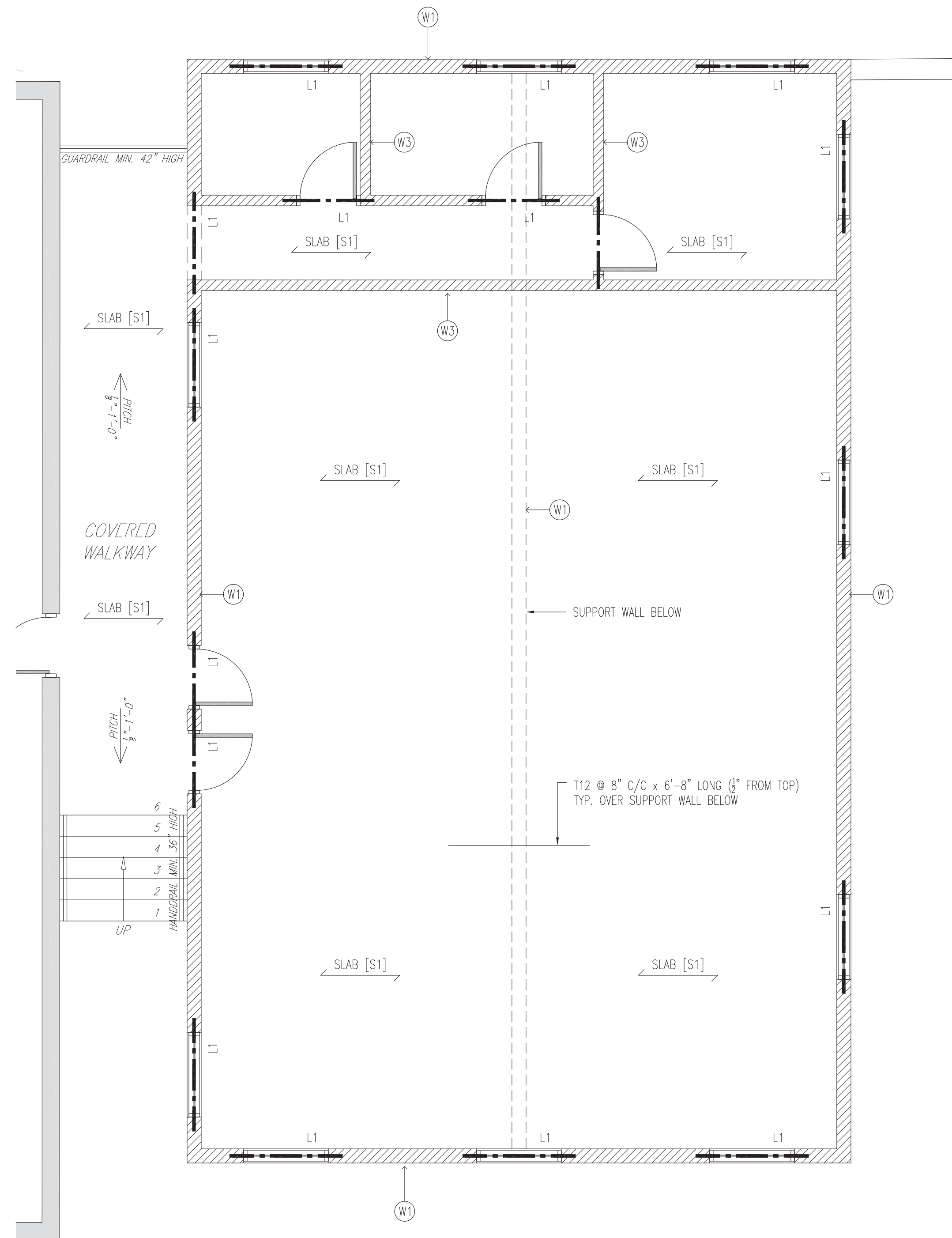

2 GROUND FLOOR PLAN
 S1.1 SCALE: 1/8" = 1'-0" (11"x17" SHEET)
 1/4" = 1'-0" (24"x36" SHEET)



MAY. 2023	-	ISSUED TO CLIENT
DATE	NO:	REVISION

BRUNEL
 ENGINEERING CONSULTANTS

t: 441.297.6191 • info@brunel.bm • www.brunel.bm

PROJECT:
 FRANCIS PATTON PRIMARY SCHOOL
 #191 NORTH SHORE ROAD
 HAMILTON PARISH, BERMUDA

TITLE:
 FOUNDATION FLOOR PLAN
 (PROPOSED)

SCALE:	AS SHOWN	JOB NO:	23-015
DRAWN BY:	JC	DRAWING #:	S1.1
DATE:	MAY 2023		

DRAWING SCALE SHOWN IS FOR FULL-SIZE DRAWINGS. DRAWINGS PLOTTED ON 11"x17" SHEETS ARE HALF SCALE SHOWN (1/4"=1'-0" ON 24"x36" SHEET = 1/8"=1'-0" ON 11"x17" SHEET)

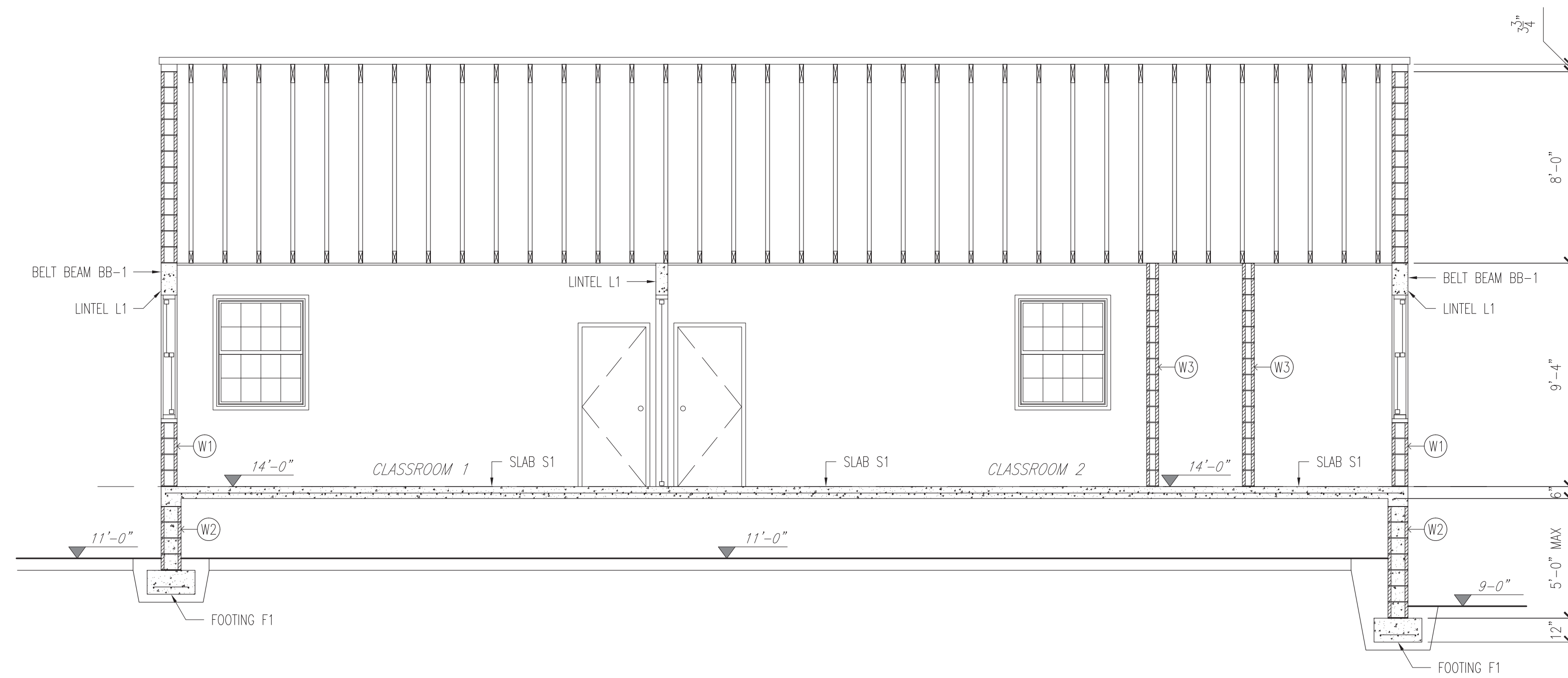

1 SECTION
S2.1 SCALE: 3/8" = 1'-0" (11"x17" SHEET)
 1/4" = 1'-0" (24"x36" SHEET)

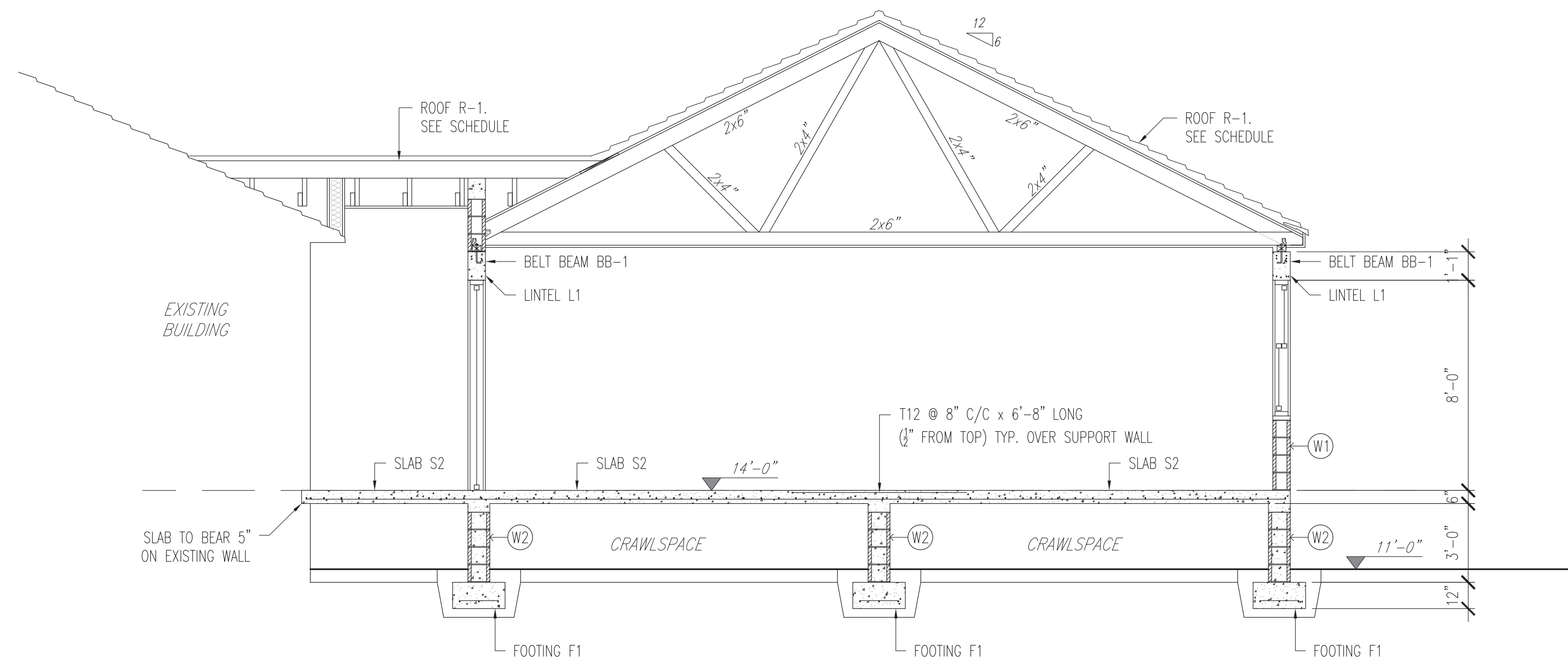

2 SECTION
S2.1 SCALE: 3/8" = 1'-0" (11"x17" SHEET)
 1/4" = 1'-0" (24"x36" SHEET)

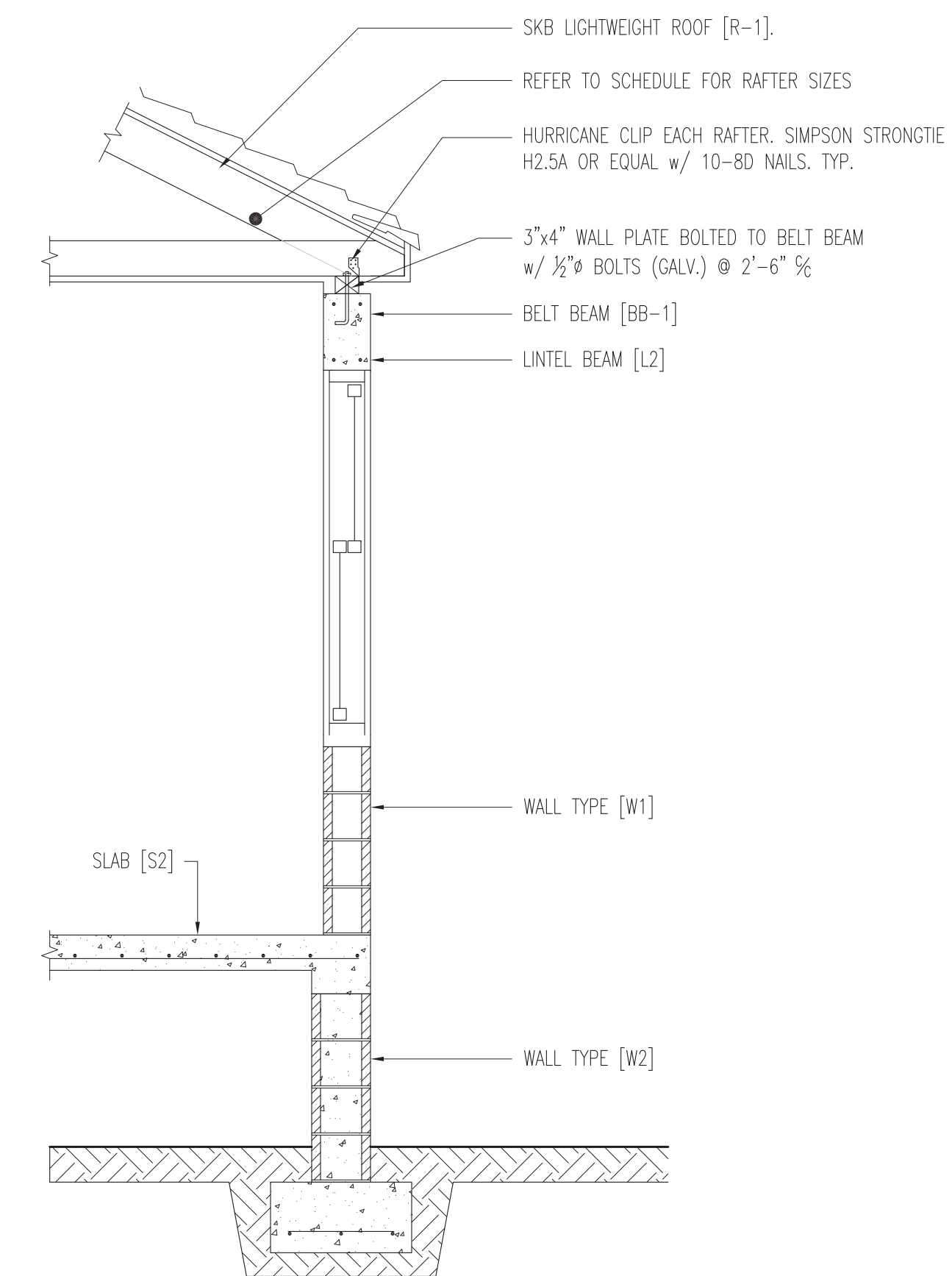

3 SECTION - DETAIL
S2.1 SCALE: 1/8" = 1'-0" (11"x17" SHEET)
 1/4" = 1'-0" (24"x36" SHEET)



MAY, 2023	-	ISSUED TO CLIENT
DATE	NO:	REVISION

BRUNEL
 ENGINEERING CONSULTANTS

t: 441.297.6191 • info@brunel.bm • www.brunel.bm

PROJECT:
FRANCIS PATTON PRIMARY SCHOOL
#191 NORTH SHORE ROAD
HAMILTON PARISH, BERMUDA

TITLE:
SECTION
(PROPOSED)

SCALE:	AS SHOWN	JOB NO:	23-015
DRAWN BY:	JC	DRAWING #:	S2.1
DATE:	MAY 2023		

DRAWING SCALE SHOWN IS FOR FULL-SIZE DRAWINGS. DRAWINGS PLOTTED ON 11"x17" SHEETS ARE HALF SCALE SHOWN (1/4"=1'-0" ON 24"x36" SHEET = 1/8"=1'-0" ON 11"x17" SHEET)